

# EAGLE LE

control unit for telescopes and astrophotography

VERSION 1.0  
Update 08-05-2021



EAGLE is manufactured by PrimaLuceLab S.p.A. (Italy). For any matters relating to the use, service and warranty, please refer to the addresses given in the relevant documents.

## English

**CAUTION:** To avoid danger of electric shock and malfunction, do not expose EAGLE to rain or moisture. The electronics are not waterproof so in adverse weather like rain or snow, the EAGLE is not to be used outdoors.

**PLEASE NOTE:** EAGLE is designed to control telescopes and accessories for astronomy and is not a standard computer. Please do not modify EAGLE system settings since this could stop some of the EAGLE features. Additionally, operating system updates are not required if your EAGLE does not connect to the internet.

**FIRST CONNECTION:** For wireless connectivity, EAGLE creates a WiFi network at the same frequency as those of usually modems / routers used to connect to the internet. So if you use EAGLE at home (for example the first time, to install your software) you might notice a low signal or, in some cases, have connection problems. You can move it to an area with fewer WiFi connections or connect it to a monitor (HDMI), keyboard (USB) and mouse (USB) to install your software.

**WINDOWS:** EAGLE includes a computer with Windows OS. For any reference on how to use Windows, please refer to the operating system user manual.

**QUALITY CONTROL:** After assembly in our laboratories, every EAGLE unit, is tested by PrimaLuceLab technical experts to verify the correct operation of all components = the integrated computer, stability and speed of the wireless connection and the power bridge.

**CAUTION:** in order to connect EAGLE to other mechanical PLUS elements please avoid to use too long screws that may touch the internal electronics of the EAGLE. **THE THREADED PART OF THE SCREW THAT EXIT FROM THE ELEMENT (ring, bar or clamp) TO BE CONNECTED TO THE EAGLE HAS TO BE NO LONGER THAN 6mm.** If any of the screws touches the internal elements of EAGLE, this could lead to breakage or malfunction.

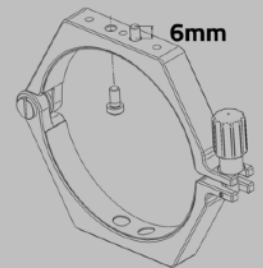

**CAUTION:** EAGLE must be powered with 12V regulated voltage. You can use a power supply with 12V output voltage or a field battery. If you use a battery, this **MUST** be provided with a proper voltage stabilization. In case of any malfunction, immediately unplug the power supply. **DO NOT CONNECT TO THE EAGLE A BATTERY WITHOUT 12V VOLTAGE REGULATOR** since it may damage the other instruments powered by EAGLE (like the cooled camera). Immediately disconnect power supplies or battery if there's any malfunction of the unit.

**CAUTION:** Before installing your devices driver and your astronomy software in the Windows operating system of the EAGLE, **PLEASE CREATE A BACKUP COPY OF YOUR SSD DISK** by following the instructions you find at paragraph "First use: backup your SSD drive before installing your software" of this user manual.

## Index

Components Identification	4
First use: how to choose the correct power source	5
First use: switch on and activation of wireless network	6
First use: Setting remote control with iPhone or iPad	10
First use: Setting remote control from a Windows computer	14
First use: Setting remote control from a Mac computer	16
First use: Setting remote control from an Android device	20
First use: backup your SSD drive before installing your software	24
First use: install your software	29
First use: turn off EAGLE	30
First use: installing EAGLE on the telescope	31
First use: powering other instruments connected to the EAGLE	34
First use: remotely control devices with EAGLE Manager	36
- <b>connect or disconnect every power out port of EAGLE</b>	<b>38</b>
- <b>set power out voltage of the 3 power out ports with adjustable voltage</b>	<b>39</b>
- <b>connect or disconnect devices attached to the 4 USB 2.0 ports</b>	<b>40</b>
- <b>check for power in voltage and battery lifetime</b>	<b>40</b>
- <b>set WiFi connectivity</b>	<b>41</b>
- <b>remotely turn on/off the entire telescope</b>	<b>43</b>
- <b>change the password of the WiFi network created by EAGLE</b>	<b>44</b>
- <b>DARK mode</b>	<b>45</b>
Advanced use: EAGLE ASCOM drivers	46
Advanced use: program connection and power to devices	47
Advanced use: remotely turn on EAGLE with wired connection	48
Advanced use: configure EAGLE to automatically start when power is restored	52
Controlling the telescope remotely with Cartes du Ciel	54
Autoguiding with PHD2 Guiding	61
Drift Alignment using PHD Guiding	66

Q & A	74
Add EAGLE's ports control in external software	76
Troubleshooting	79

## **WARNING**

If improperly handled, EAGLE may be damaged, so please follow the instructions below:

- Do not disassemble
- Do not open, damage or subject to electric shock or excessive impact any part of EAGLE. Do not drop.
- Do not short the electronic elements
- Do not expose at temperatures above 50°C
- Do not burn or incinerate any component.
- Do not wet any electronic or electric component
- Do not bend, modify or force any part of EAGLE

**NOTICE** In case you check any malfunction, please contact us immediately (+ 39-0434-1696106 or [support@primalucelab.com](mailto:support@primalucelab.com)). Do not try to disassemble, repair or modify yourself EAGLE, without our written approval, in order not to loose the manufacturer warrantee.

## Components Identification

The numbers indicate the name of the specific component. Read the paragraphs below for detailed operation description.

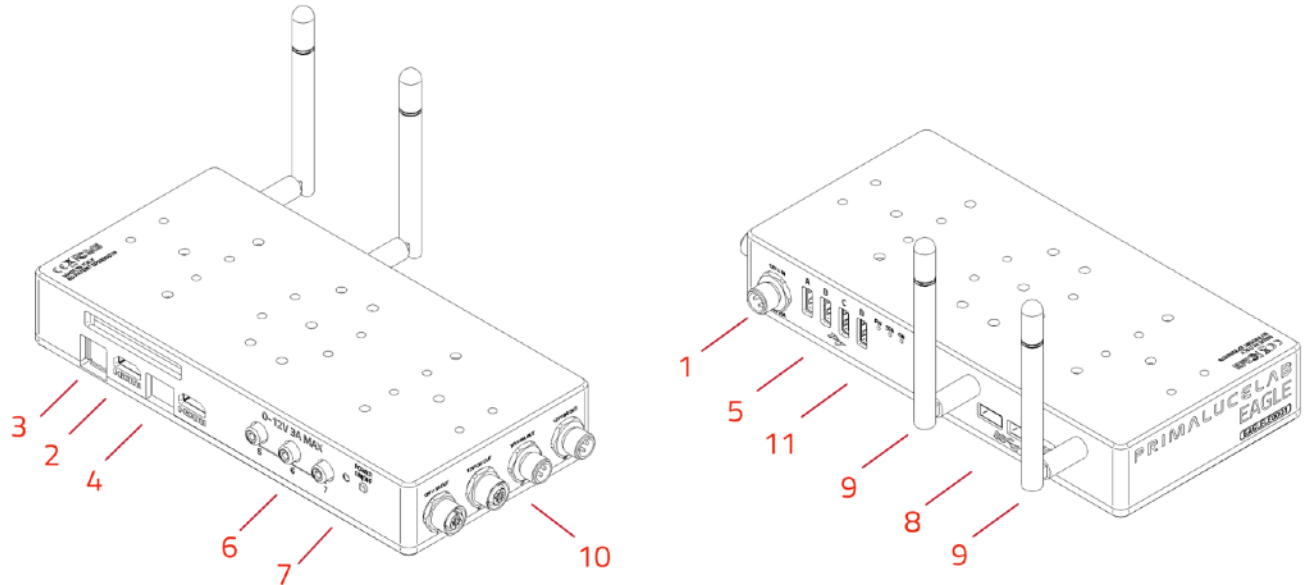

- |          |                                            |           |                   |
|----------|--------------------------------------------|-----------|-------------------|
| <b>1</b> | Power IN 12V                               | <b>7</b>  | On / Off switch   |
| <b>2</b> | HDMI port for external monitor             | <b>8</b>  | n.2 USB 3.0 ports |
| <b>3</b> | Network port                               | <b>9</b>  | WiFi Antenna      |
| <b>4</b> | n.2 USB 3.0 ports                          | <b>10</b> | n.4 12V power OUT |
| <b>5</b> | n.4 USB 2.0 ports                          | <b>11</b> | Status LEDs       |
| <b>6</b> | n.3 power out ports with regulated voltage |           |                   |

## First use: how to choose the correct power source

EAGLE allows you to distribute power to many devices used in telescopes astrophotography (such as mount, camera, filter wheel, electronic focuser, dew heaters, etc.), thus eliminating the need for many different power supplies. Since the EAGLE allows you to have a single power source (battery or AC adapter), it's important to select the correct power source to properly power all the devices you want to use.

### CAUTION

EAGLE must be powered with 12V regulated voltage. You can use a power supply with 12V output voltage or a field battery. If you use a battery, this **MUST** be provided with a proper voltage stabilization. In case of any malfunction, immediately unplug the power supply. **DO NOT CONNECT TO THE EAGLE A BATTERY WITHOUT 12V VOLTAGE REGULATOR** since it may damage the other instruments powered by EAGLE (like the cooled camera). Immediately disconnect power supplies or battery if there's any malfunction of the unit.

### Which battery or power supply have I to use for my equipment?

The power supply or battery you need to use to power the EAGLE and all peripherals connected to it depends on the electric current needed to power all the instruments plus the EAGLE. Let's make an example by considering the EAGLE basic model, that needs for an average of 0,6 Ah:

- EAGLE: 1,2Ah maximum consumption (average consumption: 0,6Ah)
- Cooled camera: 4Ah maximum consumption (average consumption: 3Ah)
- Computerized mount: 2Ah maximum consumption (average consumption: 1Ah)
- Guide camera: 0 consumption (power from the USB port of EAGLE)

We'll have a total maximum power consumption: 7,2Ah. So, for this setup, you should use the 14A AC adapter. If you want to use a battery (**WARNING: The battery must have a 12V voltage regulator with protection system**) that can power the entire system for 8 hours (for example for the duration of an astronomical night), you will need a battery with a capacity of at least:

$$7,2\text{Ah (consumption per hour)} \times 8 \text{ (hours duration)} = 57,6 \text{ Ah}$$

### TIP

When many devices are powered through the EAGLE (and Ampere consumption exceeds 5Ah) we recommend the use of a power supply or battery with voltage regulator set to 12.8V volts instead of 12V. This is because, when you distribute power to many devices and you have a high power consumption, there's a normal and small voltage drop: by setting your source at 12.8V, you will have a voltage of 12.xV in the EAGLE's power out ports and this will be fine with all your 12V powered devices. The important thing is to have the voltage not lower than 12.0V. In order to create a large capacity field battery and have a voltage of 12.8V, you can connect to the battery a 220V inverter and then connect to this the standard **12.8V 12A AC adapter for EAGLE.**

## First use: switch on and activation of wireless network

EAGLE is designed to be controlled from an external device (not included with EAGLE) via WiFi. You can use any mobile device (tablet or smartphone) with any operating system (iOS or Android) or any computer (Windows or macOS). For remote control, you will need to download the **“Microsoft Remote Desktop”** app onto the device (smartphone, tablet, or computer) that you will use to control your EAGLE. Depending on the App Store for your system, the application can also be found under the name **“RD Client Microsoft”**. The Remote Desktop client is free and compatible with all operating systems - iOS, Android, Windows and macOS. As an alternative, you can also use the **“Parallels RDP Client”** that is free and available for different operating systems.

Install the 2 WiFi antennas (9) included in the package by threading them onto the the proper ports on the side of EAGLE with the status LEDs.

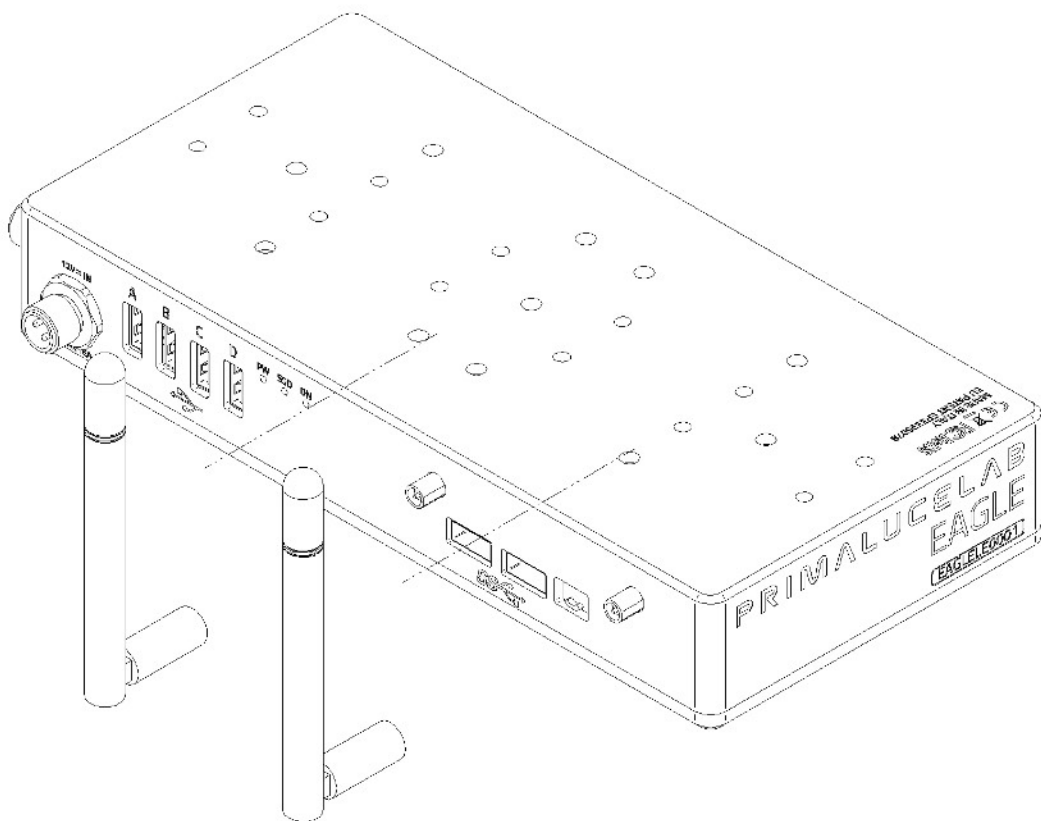

*Image 1: thread the WiFi antennas to the proper ports*

In order to power EAGLE with a 12V battery equipped with a cigarette lighter socket, use the 12V cable with cigarette lighter socket that you find in the EAGLE package. Insert the power cable (image 2) into the appropriate soc-

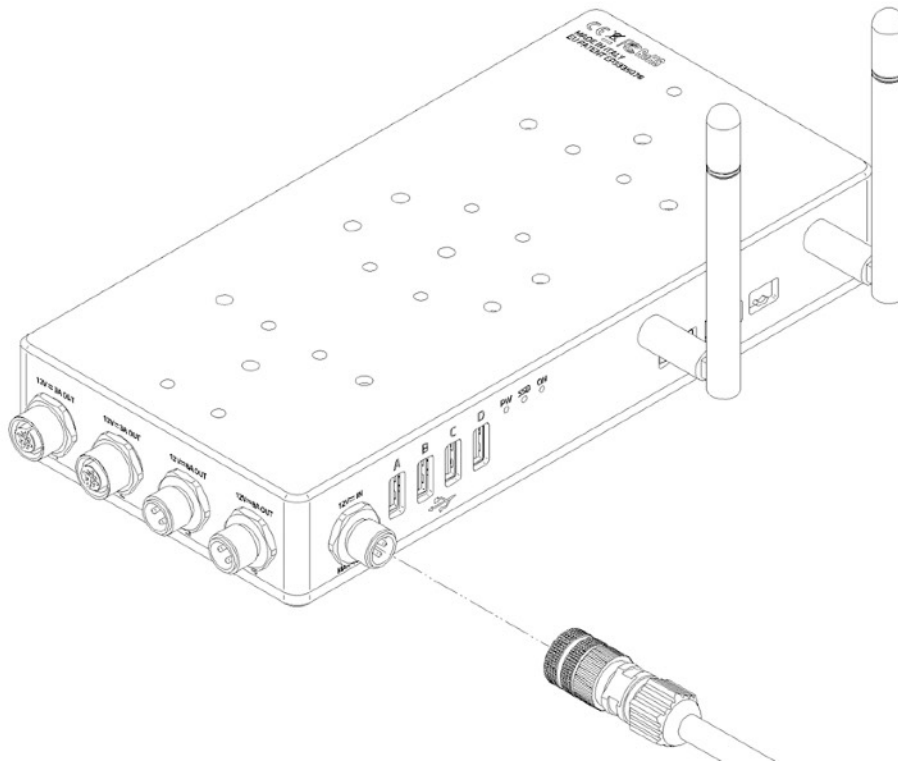

Image 2: Connect the power plug into the socket (1)

ket (1 - 12V power input), you will hear a beep sound and the PW LED light will turn on. If you want to power EAGLE from the 110/220V wall plug, replace the power cable with the optional 12.8V power supply. Then press the power button (7). The ON LED will light up and the SSD LED will start blinking, this means Windows is booting.

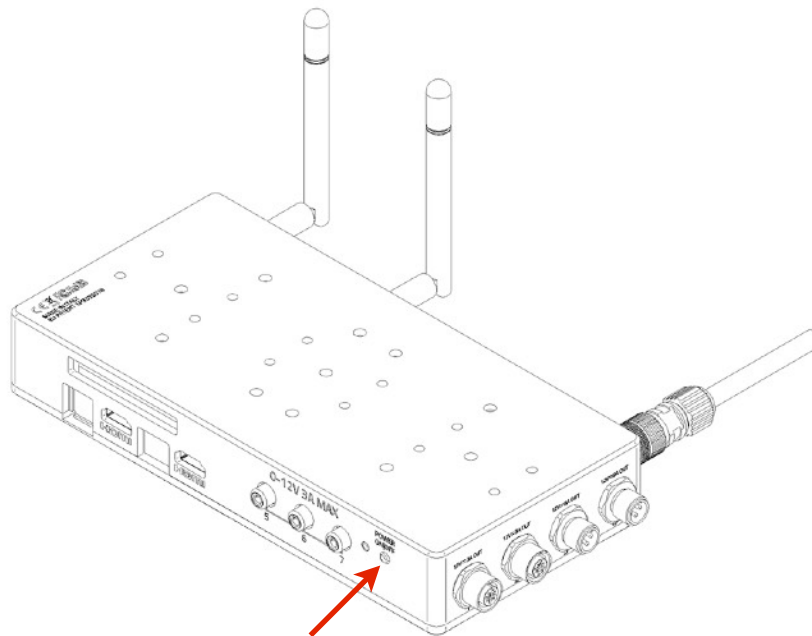

Image 3: press the Start button (7) to switch EAGLE on



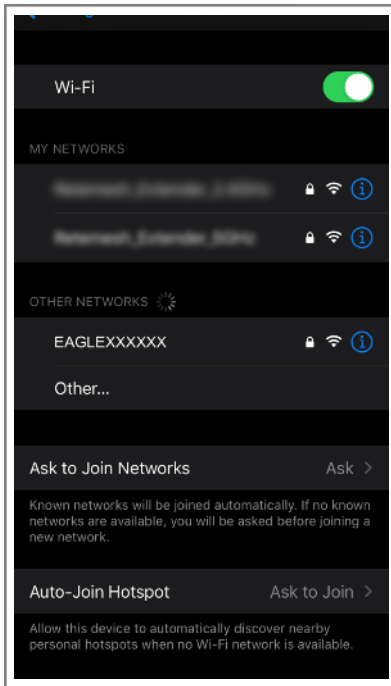

Image 4: select the WiFi net created by EAGLE

Now wait about one minute and you will hear a second beep sound. This indicates that the EAGLE's WiFi connection is ready. On the side of the EAGLE case you will see the STS LED light turn green, this means that Windows has booted correctly. Turn on your WiFi device you choose to control EAGLE. The network name is EAGLEXXXXXX (where the XXXXXX is the serial number of your EAGLE as written also is also on the EAGLE's case).

Look at the list of WiFi networks shown on your device (identification mode of wireless networks depends on the control device you use, so if you do not know how to search for WiFi networks, please read the manual of your device) and select the network created by EAGLE (picture 4).

A window will appear where you will be asked to enter the password of your network (image 5). The password is **primalucelab**. Using the keyboard (virtual or physical) of your device, enter the password paying attention to appropriate upper or lower case. Then press the CONNECT.

(Note: Each EAGLE has a different Windows login password known only to you; **the password is shown on the EAGLE quick guide that you find in the box**. This way it is safe to use your EAGLE at a star party where other EAGLE users might be present).

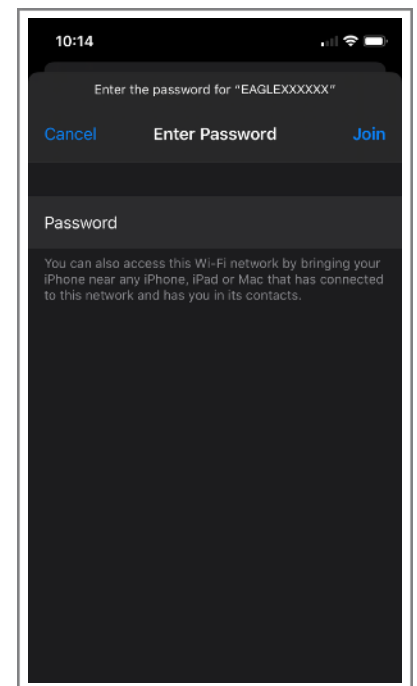

Image 5: insert network password

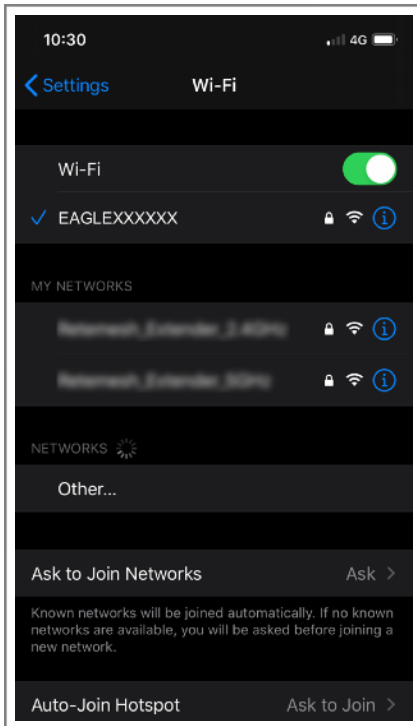
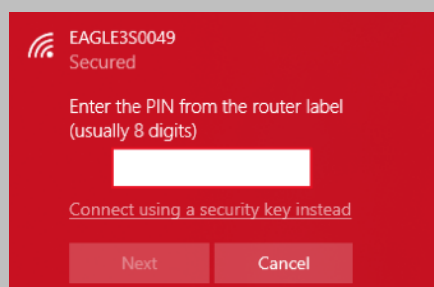

Image 6: connection to WiFi network.

Then EAGLE WiFi network connection is confirmed (image 6). The network setting is complete and the next time you want to access the EAGLE you will no longer need to enter your password: your device will connect automatically when you select the network created by EAGLE.

## NOTE

On Windows operating systems, when you select EAGLE's WiFi network, you may be requested to insert a "PIN from the router label". Please click on the "Connect using a security key instead" and then type the password "primalucelab".



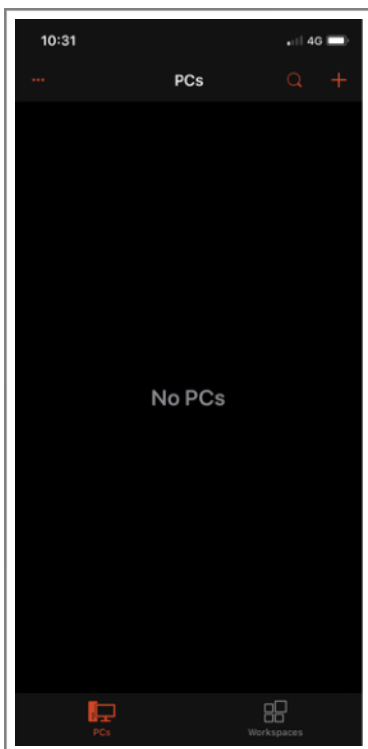

## First use: Setting remote control with iPhone or iPad

This guide has been written by using an iPhone with iOS 13.6 and Microsoft Remote Desktop client 10.1.2 (and it has been tested also with iPad using iPadOS 13.6 and Microsoft Remote Desktop client 10.0.6). From the App Store of your iPhone/iPad, please search and install the "**Microsoft Remote Desktop**" app. If you do not know how to install the app from the App Store, please read the manual of your iPhone/iPad.



Start the "**Microsoft Remote Desktop**" app. You will see a screen like the one visible in the image 7. Click the + button (top-right), then select "Add PC".

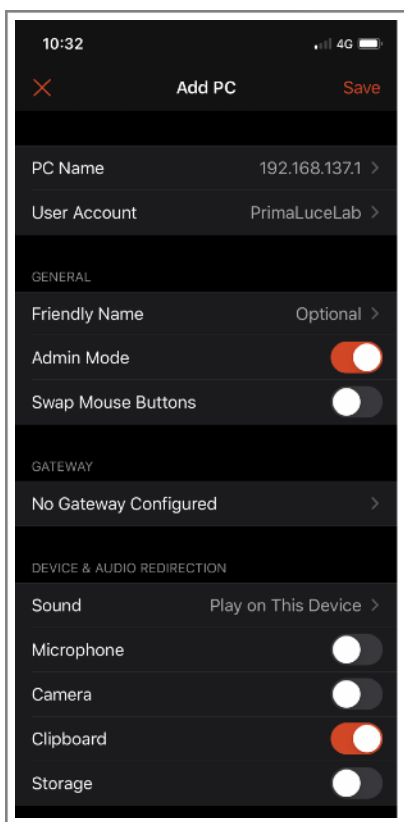

In the window that opens, in "PC name" enter 192.168.137.1

Then select the "User Account" field and choose "Add user account". A window will open (picture 8) where you can enter your username and password to log on to Windows.

The values are:

- Username: *PrimaLuceLab*;
- Password: (that shown on the quick guide in the EAGLE box)

Then press the button "Save" to save the access data.

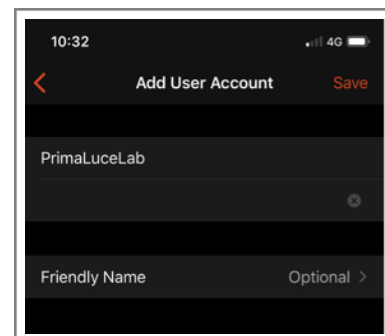

*Image 8: Insert User name and Windows access password.*

**WARNING:** when entering your data check that your device does not automatically insert a space after the word "username" and "password".

Then (image 9), select the option "Admin Mode" and press the "Save" button to confirm and save the access data.

*Image 9: Press "Save" to confirm access data.*

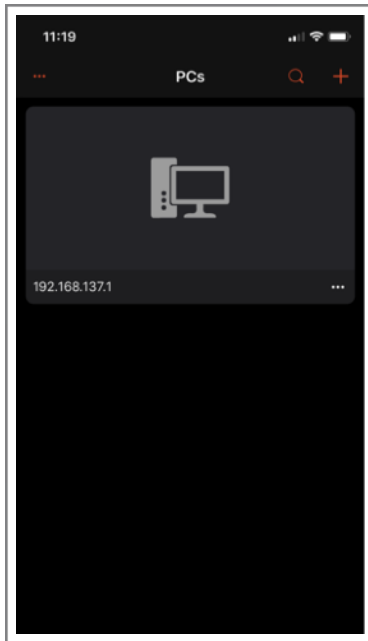

Image 10: Select the created link

Returning to the main page you will find a new connection (picture 10). Tap on it and wait a few seconds, you'll see on your device's desktop EAGLE (image 11).

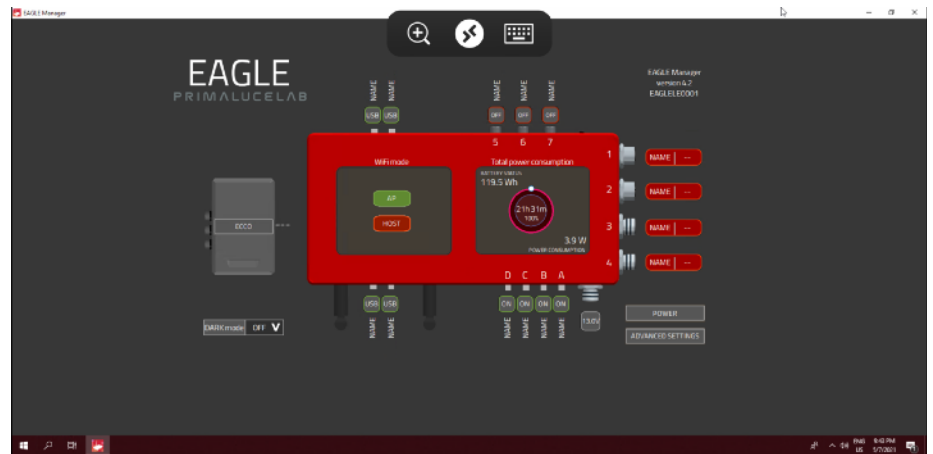

Image 11: EAGLE start screen

Now can use the screen of your iPhone or iPad like mouse and keyboard of EAGLE. There are two modes of use, that can be selected by pressing the central-up button (between the magnifying glass and the keyboard) to see the options. By default, the app works in "mouse" mode to display the classic Windows pointer that you can move with your finger and click on the icons and buttons visible on the screen. Instead, if you want to use the touch mode (as you usually do with tablets or smartphones), click the central button at the top (image 12) and select the hand button (the icon next to the house).

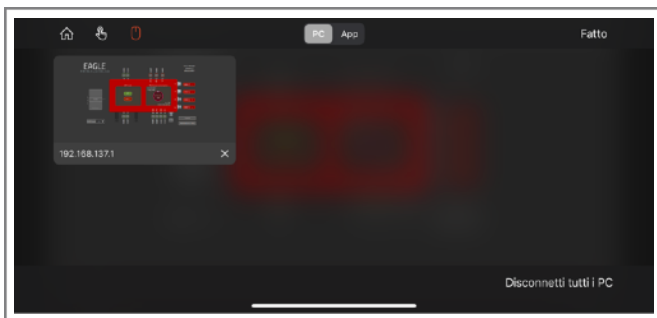

Image 12: By clicking the central-top button (between magnifier and keyboard), you will see the options.

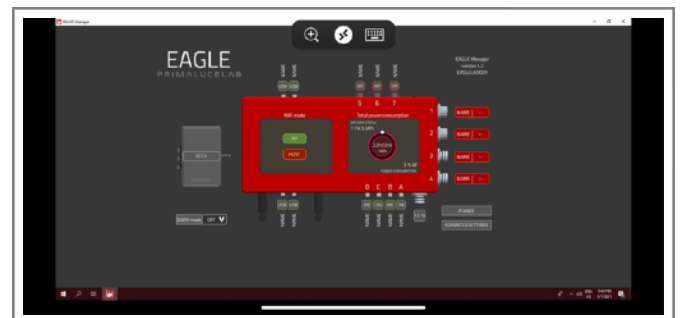

Image 13: By clicking the hand button (the icon close to the house), control will turn in touch-screen mode

To simulate a single mouse click (like pressing the left button of the mouse) just "tap" on the screen. To simulate the right mouse button, place a finger on the screen (and do not move it), and then "tap" with another finger to make options appear.

**NOTE:** You can also use another Remote Desktop client, the "Parallels Client" (you can download from the App Store). This client has to be set as the Microsoft one, the only difference is that this will ask also the Port number, please set it to 3389.

## NOTE

**After being connected to the EAGLE's WiFi, I start a Remote Desktop connection but I get an error “Unable to connect”. How can I fix this?**

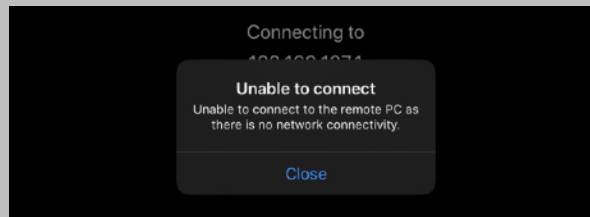

This error may happen if your iPhone or iPad doesn't have an internet connection, for example when (or if) it doesn't have a 4G connection. In this case, please proceed this way:

- 1) In the iPhone/iPad please go to Settings > Wifi, and select your EAGLEXXXXXX network. Once selected, tap on the “i” icon to the right.

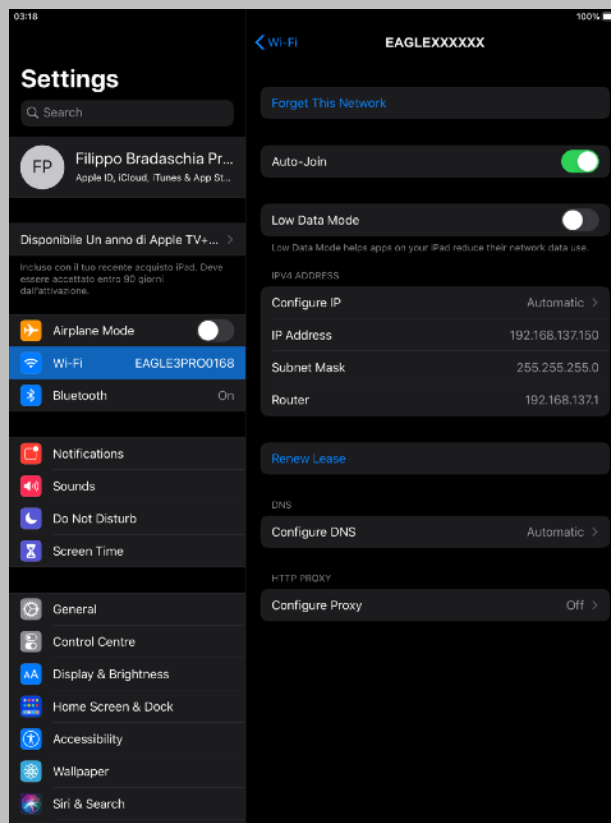

- 2) Next tap on “Configure DNS” and change the selection from “Automatic” to “Manual”, and tap on “Add server”. Here you type the IP address of your EAGLE (192.168.137.1) as the DNS server. Press the “Wi-Fi” blue text on the top to confirm.

- 3) With the IPv4 address and DNS settings configured manually, the Remote Desktop should work correctly. Please launch again the Microsoft Remote Desktop app and start the connection.

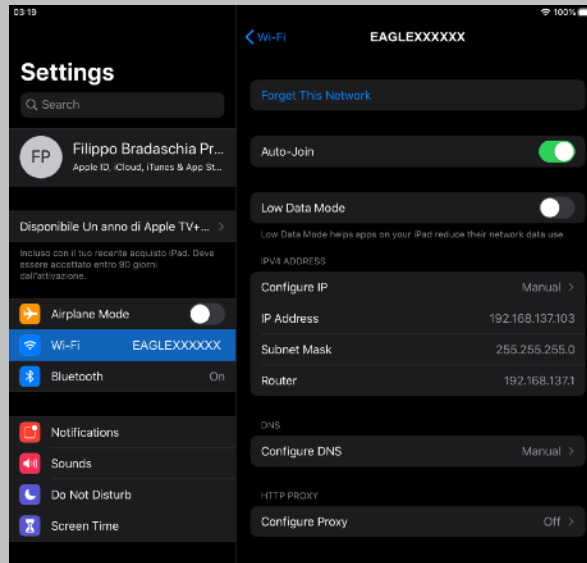

## First use: Setting remote control from a Windows computer

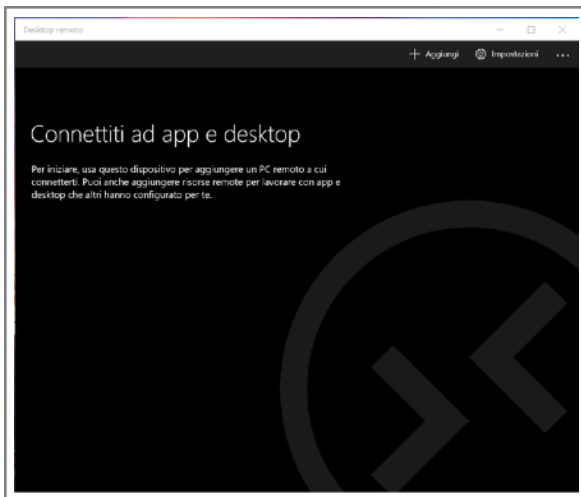

Image 14: Press the + button to add the parameters to access your EAGLE.

This guide has been written by using a Windows 10 Home and Microsoft Remote Desktop client 10.1.1215.0 and it has been tested also with a computer running Windows 10 Pro. From the Microsoft Store of your computer, please search and install the "**Microsoft Remote Desktop**" app. If you do not know how to install the app from the Microsoft Store, please read the manual of your computer.



Thanks to the remote control app, you have the EAGLE with all your software on your device screen. Start the "**Microsoft Remote Desktop**" app. You will see a screen like the one visible in the image 14. Click the + button (top-right), then select "Desktop".

In the window that opens, in "PC name" enter 192.168.137.1  
Then select the "User Account" field and choose "Add user account".  
A window will open (picture 15) where you can enter your username and password to log on to Windows.

The values are:

- Username: *PrimaLuceLab*;
- Password: (that shown in the flyer in the EAGLE box)

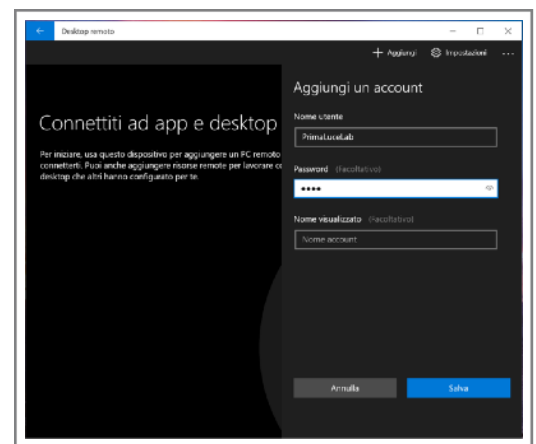

Image 15: Insert User name and Windows access password.

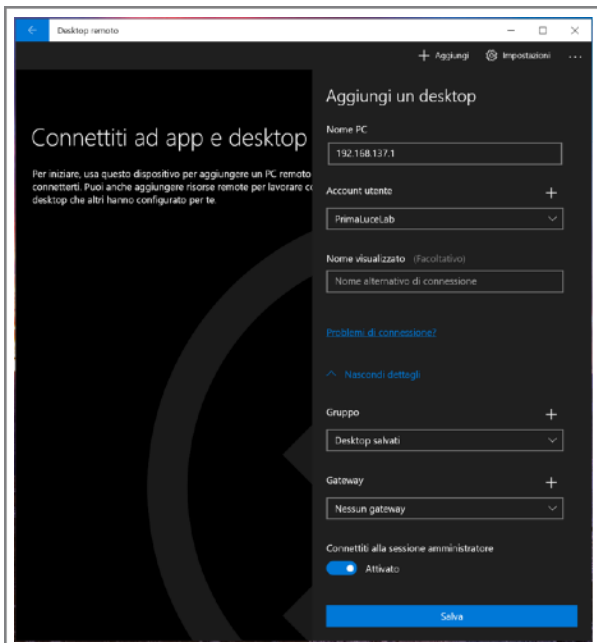

Image 16: Press "Save" to confirm access data.

Then press the button "Save" to save the access data.

**WARNING:** when entering your data check that your device does not automatically insert a space after the word "username" and "password".

Then (image 16), select the option "Connect to admin Mode" and press the "Save" button to confirm and save the access data.

Returning to the main page you will find a new connection (picture 10).

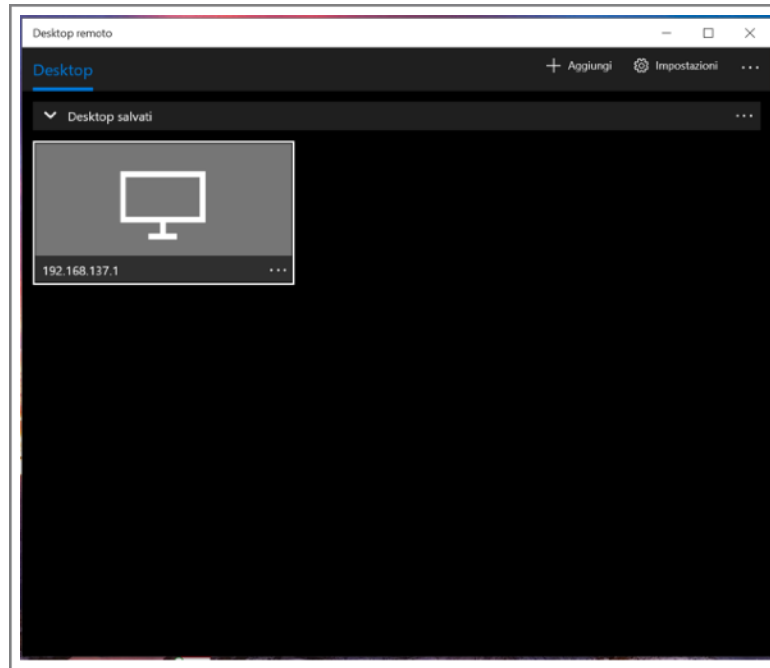

Image 17: Select the created link

Double click on the connection and you will be connected to the EAGLE Manager (image 18). Now you are ready to use the software you prefer to control your telescope.

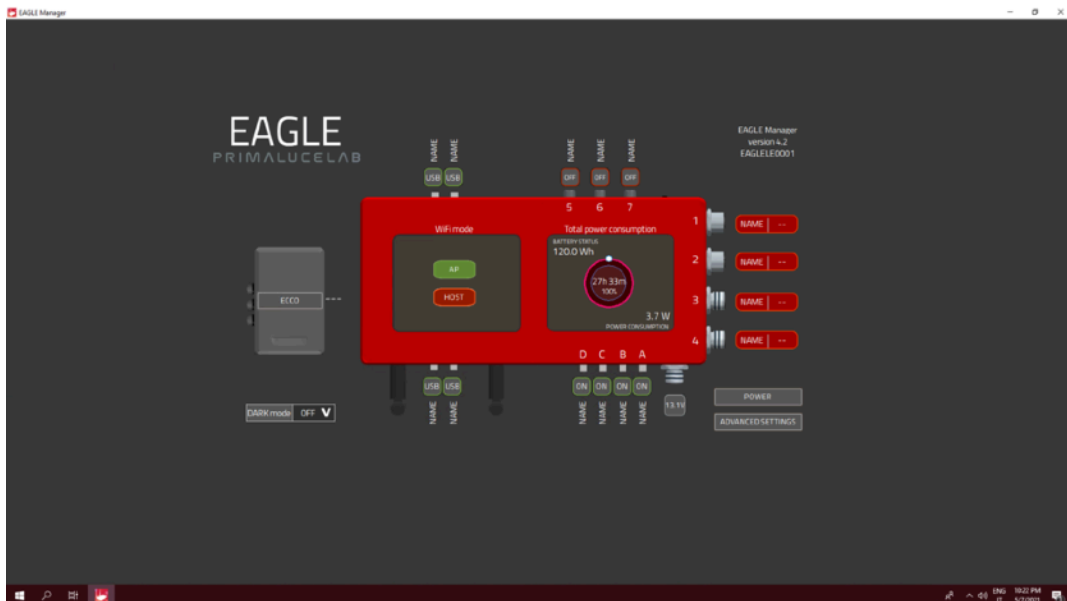

Image 18: EAGLE start screen

**NOTE:** You can also use another Remote Desktop client, the “Parallels Client” (you can download from here <https://www.parallels.com/products/ras/capabilities/rdp-client/>). This client has to be set as the Microsoft one, the only difference is that this will ask also the Port number, please set it to 3389.



## First use: Setting remote control from a Mac computer

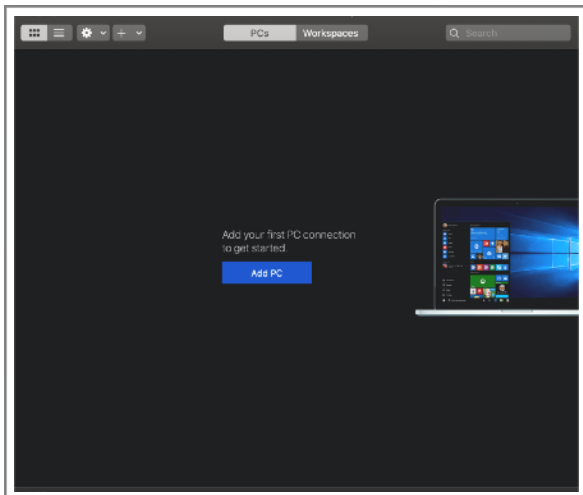

Image 19: Press the + button to add the parameters to access your EAGLE.

This guide has been written by using a macOS Catalina 10.15.6 and Microsoft Remote Desktop client 10.4.0 (1811). From the Mac App Store of your computer, please search and install the "**Microsoft Remote Desktop**" app. If you do not know how to install the app from the Mac App Store, please read the manual of your computer.



Thanks to the remote control app, you can have your EAGLE with all your software right on your device's screen. Start the "**Microsoft Remote Desktop**" app. You will see a screen like the one visible in the image 19. Click the + button (top-right), then select "Add PC".

In the window that opens, in "PC name" enter 192.168.137.1. Then select the "User Account" field and choose "Add user account". A window will open (picture 20) where you can enter your username and password to log on to Windows.

The values are:

- Username: *PrimaLuceLab*;
- Password: (that shown in the flyer in the EAGLE box)

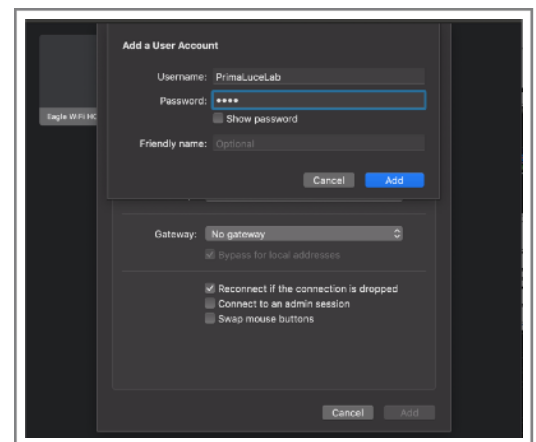

Image 20: Insert User name and Windows access password.

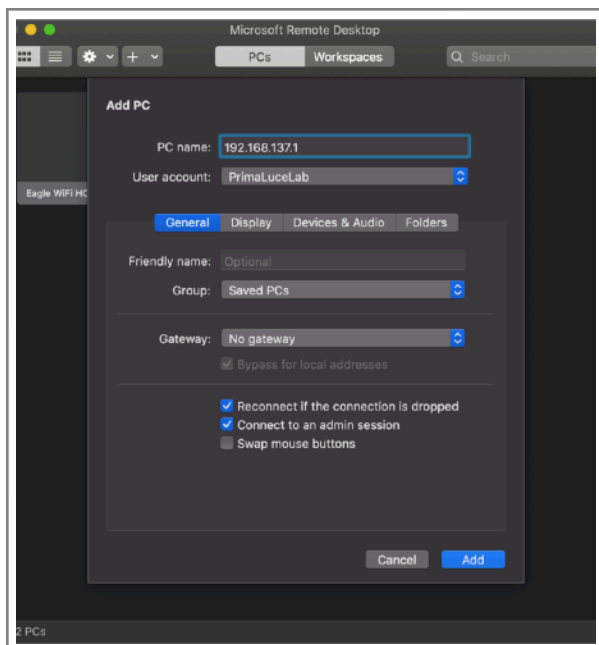

Image 21: Press "Add" to confirm access data.

Then press the button "Save" to save the access data.

**WARNING:** when entering your data check that your device does not automatically insert a space after the word "username" and "password".

Then (image 21), select the option "Connect to an admin session" and press the "Add" button to confirm and save the access data.

Returning to the main page where you will find your new connection (picture 22).

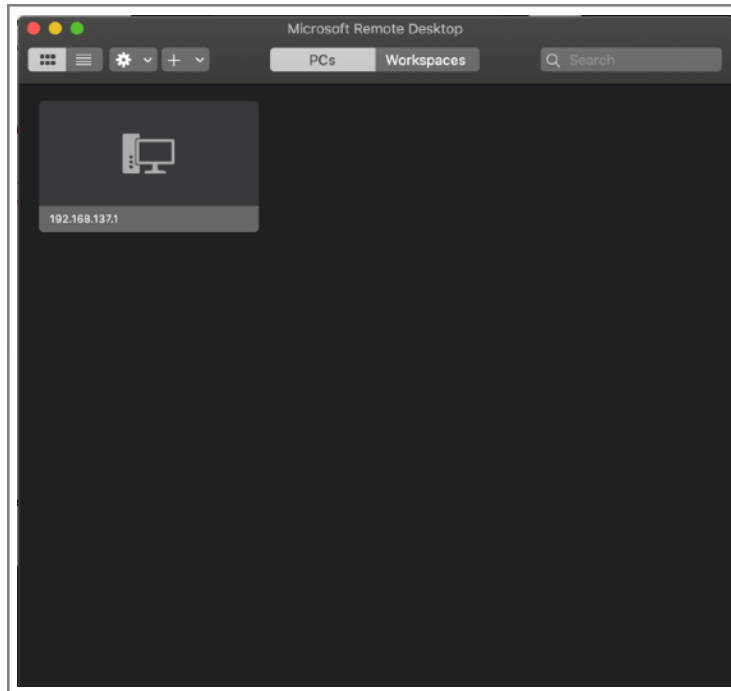

Image 22: Select the created link

Double click on the connection and you will be connected to the EAGLE Manager (image 23). Now you are ready to use the software you prefer to control your telescope.

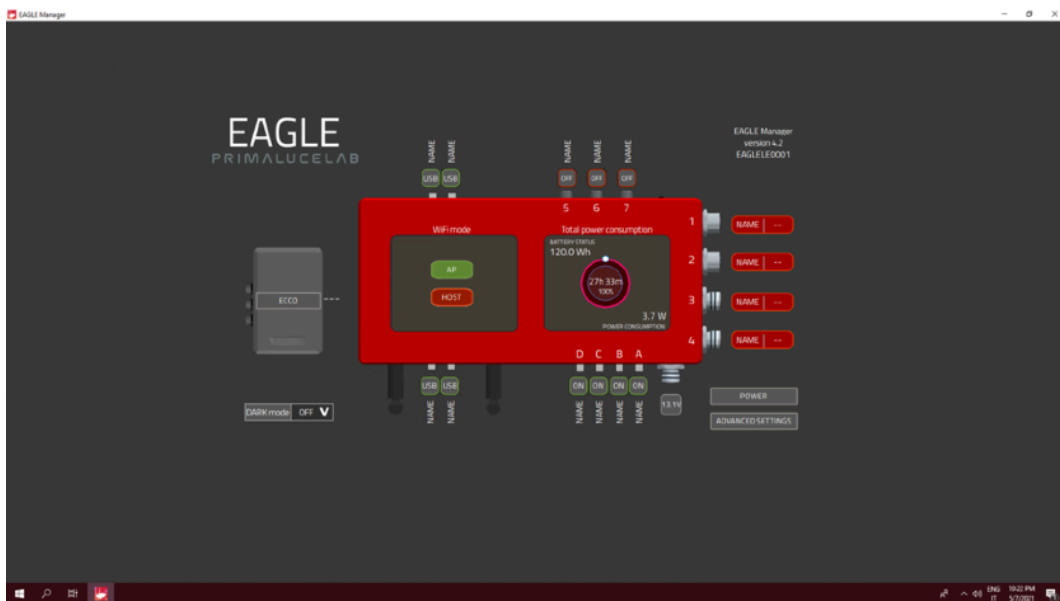

Image 23: EAGLE start screen

**NOTE:** You can also use another Remote Desktop client, the “Parallels Client” (you can download from here <https://www.parallels.com/products/ras/capabilities/rdp-client/>). This client has to be set as the Microsoft one, the only difference is that this will ask also the Port number, please set it to 3389.

### NOTE

## After being connected to the EAGLE's WiFi, I start Remote Desktop connection but I get an error “Unable to connect”. How can I fix this?

This error may happen if your Mac is not connected to the internet. In this case, we must configure a manual IP address on your Mac, when connected to the EAGLE. To be able to switch between network configurations easily/cleanly on a Mac, you should create a location for your EAGLE, and switch between locations under the Apple menu. To create a location, do the following:

- 1) Open System Preferences, and go to “Network” - once there, select the pull-down menu next to “Location”. Select “Edit Locations”. Click on the “+” symbol; to create a new location, and give it a name in the field provided.

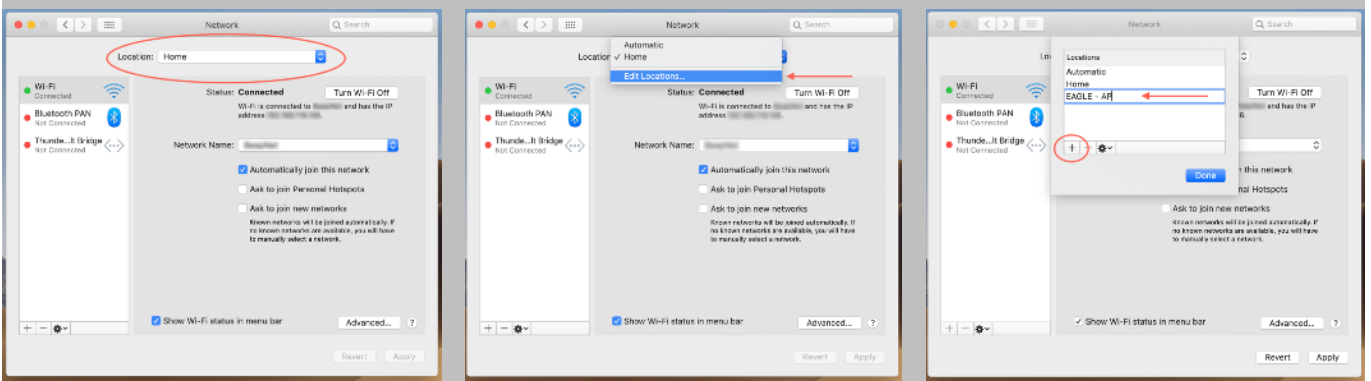

- 2) Next, select the name of the WiFi network of your EAGLE. With the network selected, click “Advanced”. Click on the “TCP/IP” tab, and click on the pulldown menu for “Configure IPv4” to change from “Using DHCP” to “Manually”. With “Manually” selected, you must enter a valid IP address for the network of your EAGLE. The IP address of your EAGLE’s AP interface is 192.168.137.1. An address must be selected in the same network range, and it must be unique. This is done by changing the last “octet” of the network address. Your EAGLE ends in “.1” You can select any other address starting with “.2, and going to “.254”. Remember if you have multiple devices accessing your EAGLE, you should choose and assign a unique IP to each device. In this example, I have chosen “.102” - so the IP address I have configured is “192.168.137.102. Configure the netmask and router as shown. The router is the IP address of your EAGLE.

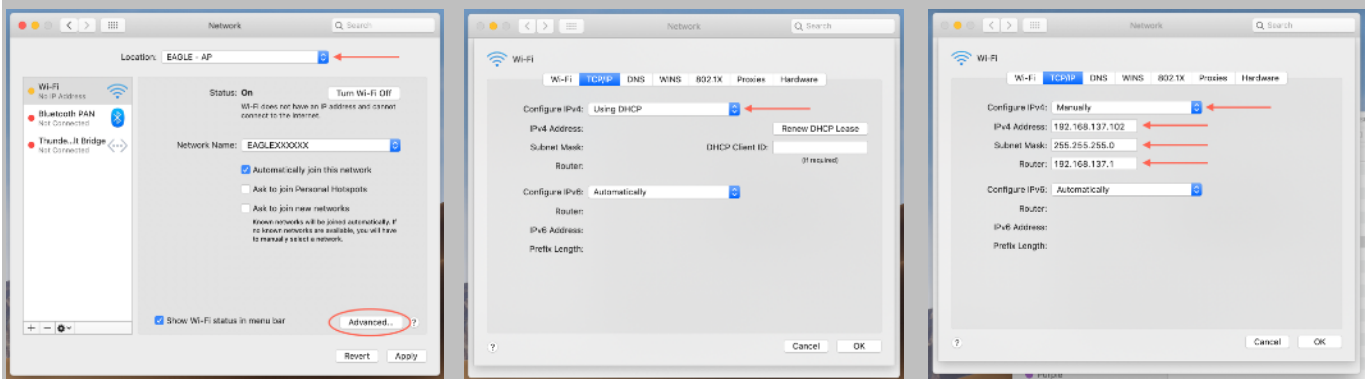

- 3) Next, click on the “DNS” tab. Under “DNS Servers” click the “+” symbol to add a server, and again, use the IP address of your EAGLE, like the example above. When done, click OK. Click Apply. Switch to the new location you created under the Apple menu > Location > (your location name).

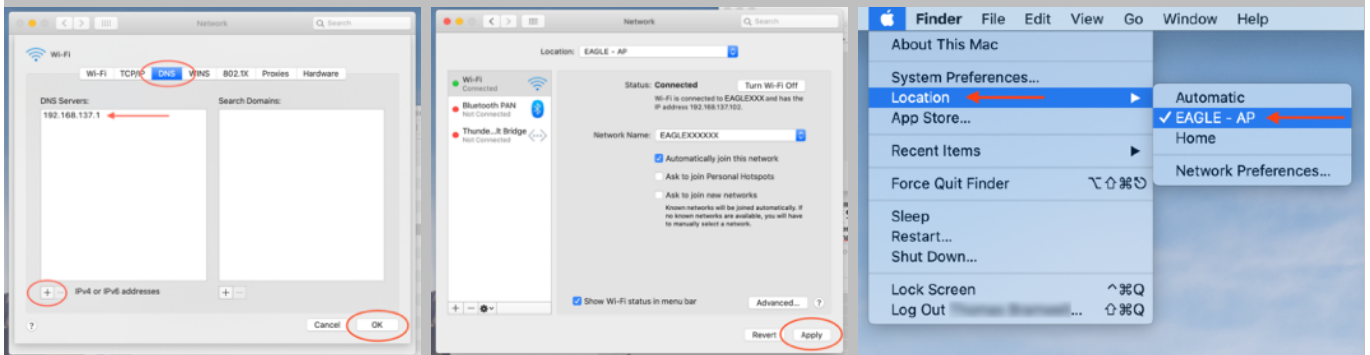

- 4) Check that now your Mac is connected to the EAGLE’s WiFi and start the Remote Desktop connection.

If you still have the same error, this could be related to the access data saved in your Mac memory. In order to delete previous saved access data, please enter the “Keychain” and type, in the upper-right field, the name of your EAGLE’s WiFi network. Then select all the results, make a right mouse click and select Delete All.

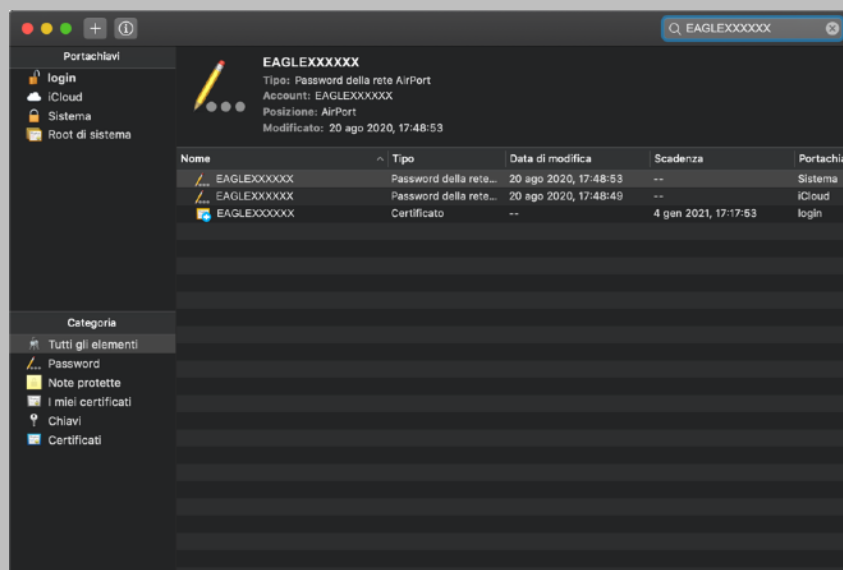

This will remove all the access data saved related to your EAGLE’s WiFi network. Please connect again to the EAGLE’s WiFi (you will be requested to enter again the “primalucelab” password) and start the Remote Desktop connection to your EAGLE.

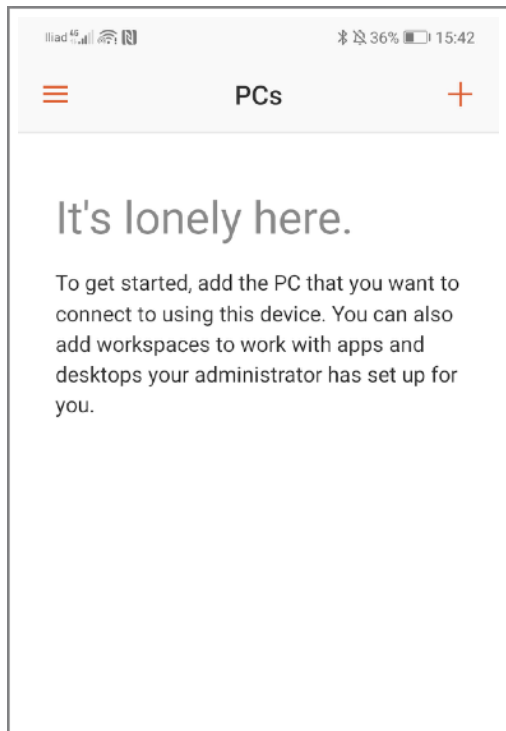

Image 24: Press the + button to add the parameters to access your EAGLE.

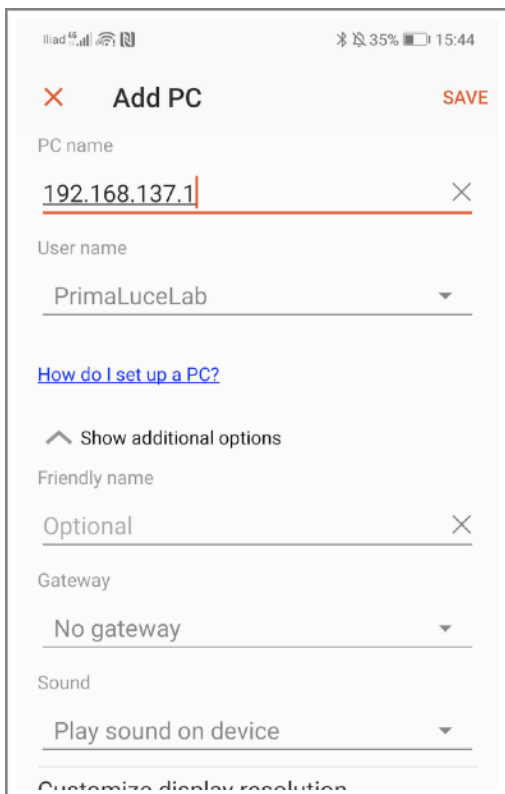

Image 26: Press "Add" to confirm access data.

## First use: Setting remote control from an Android device

This guide has been written by using an Android smartphone 9.1 and Microsoft Remote Desktop client 10.0.7.1066. From the Google Play Store of your device, please search and install the "**Microsoft Remote Desktop**" app. If you do not know how to install the app from the Google Play Store, please read the manual of your computer.



Thanks to the remote control app, you have access to your EAGLE with all your software right on your device's screen. Start the "**Microsoft Remote Desktop**" app. You will see a screen like the one visible in the image 24. Click the + button (top-right), then select "Add PC".

In the window that opens, in "PC name" enter 192.168.137.1

Then select the "User name" field and choose "Add user account". A window will open (picture 25) where you can enter your username and password to log on to Windows.

The values are:

- Username: *PrimaLuceLab*;
- Password: (that shown in the flyer in the EAGLE box)

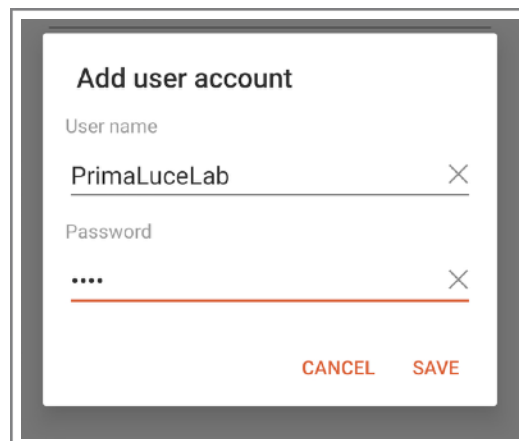

Image 25: Insert User name and Windows access password.

Then press the button "Save" to save the access data.

**WARNING:** when entering your data check that your device does not automatically insert a space after the word "username" and "password".

Then (image 26), select the option "Connect to an admin session" and press the "Add" button to confirm and save the access data.

Returning to the main page you will find a new connection (picture 27).

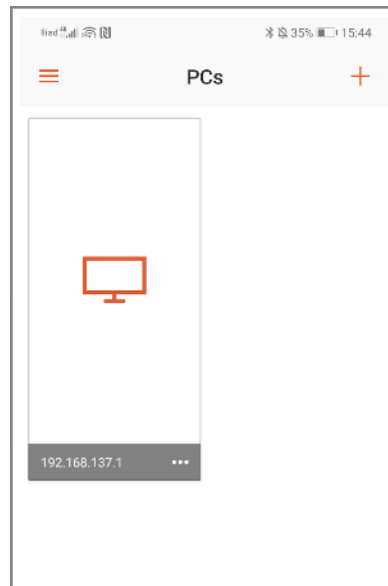

Image 27: Select the created link

Double click on the connection and you will be connected to the EAGLE Manager (image 28). Now you are ready to use the software you prefer to control your telescope.

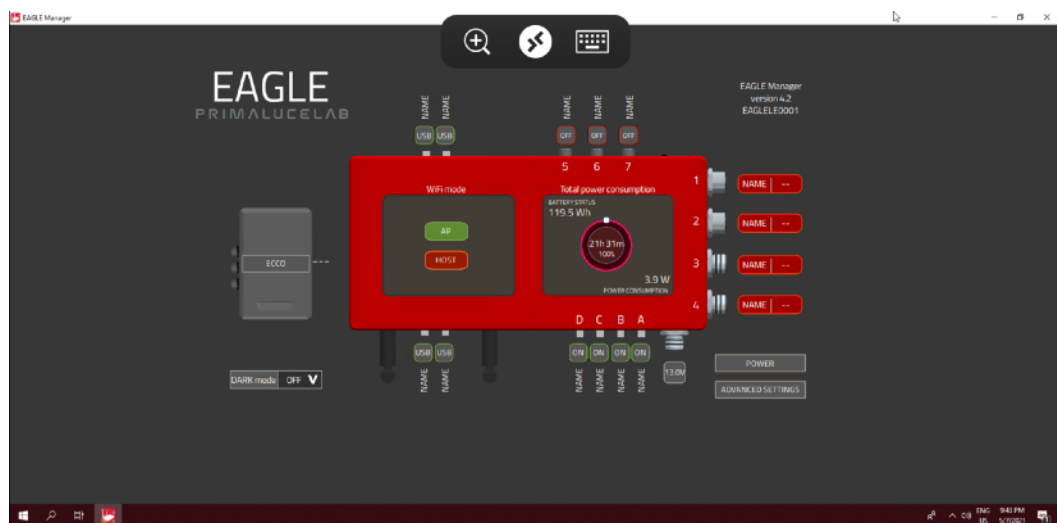

Image 28: EAGLE start screen

**NOTE:** You can also use another Remote Desktop client, the “Parallels Client” (you can download from Play Store). This client has to be set as the Microsoft one, the only difference is that this will ask also the Port number, please set it to 3389.

## NOTE

### After being connected to the EAGLE's WiFi, I start Remote Desktop connection but I get an error "Unable to connect". How can I fix this?

This error may happen if your Android device doesn't have an internet connection, for example when (or if) it doesn't have a 4G connection. In this case, please proceed this way:

- 1) In the Android device please select the Wifi settings of the EAGLEXXXXXX network you connected to.



- 2) Here we have to write a manual IP address for the network of your EAGLE. The IP address of your EAGLE's AP interface is 192.168.137.1. An address must be selected in the same network range, and it must be unique. This is done by changing the last "octet" of the network address. Your EAGLE ends in ".1" You can select any other address starting with ".2, up to ".254". Remember if you have multiple devices accessing your EAGLE, you should choose and assign a unique IP to each device. In this example, we have chosen ".103" - so the IP address we have configured is "192.168.137.103. Configure the netmask and router as shown in the example above. The router is the IP address of your EAGLE. Press the blue EAGLEXXXXXX text on top left to confirm.

Gateway

192.168.137.1

Lunghezza prefisso rete

24

DNS 1

192.168.137.1

- 3) Next configure DNS to the IP address of your EAGLE (192.168.137.1).

**Certificate can't be verified.  
Do you want to connect anyway?**

You are connecting to:

192.168.137.1

Name in certificate from the remote PC:

EAGLE3S0049

It may not be safe to connect to this PC  
because of the following reason:

- Not from a trusted certifying authority
- PC name mis-matched

Never ask again for connections to this PC

More details

CANCEL CONNECT

- 4) With the IPv4 address and DNS settings configured manually, the Remote Desktop should work correctly. Please launch again the Microsoft Remote Desktop app and start the connection. If the "Certificate can't be verified" window appears, please select "Never ask again for connections to this PC" and click CONNECT button to start.



## First use: backup your SSD drive before installing your software

**Before installing your devices driver and your astronomy software in the Windows operating system of the EAGLE, we suggest you to create a backup copy of your SSD.** In fact, after production and testing of your EAGLE, we always record a “Windows Restore Point” that you can use if the software and driver you use create problems in Windows and you want to come back to factory settings. But, since main Windows Updates automatically delete recovery points, we recommend you also to make a backup copy of your SSD drive.

*If you don't do a backup copy of your SSD drive and if in the future you will have problems with the Windows installation of your EAGLE, you will have to ship us back the entire unit (since every EAGLE is different because, for example, every EAGLE has its remote control codes) because we can only do this reset in our laboratory.*

There are plenty of services to back up your files, but we'll be using **Macrium Reflect Free**. It's free and easy to use. To install Macrium Reflect, go to <https://www.macrium.com/reflectfree>, click on "Home Use" button. **Your EAGLE has to be connected to the internet (for example, by connecting the EAGLE to your router by using an Ethernet cable) in order to correctly download and install Macrium Reflect.**

Once you downloaded the installation file, please double click on it in order to start the installation procedure, as you can see in the picture on the right. You can safely delete all the installer files from your Downloads folder once the wizard has finished.

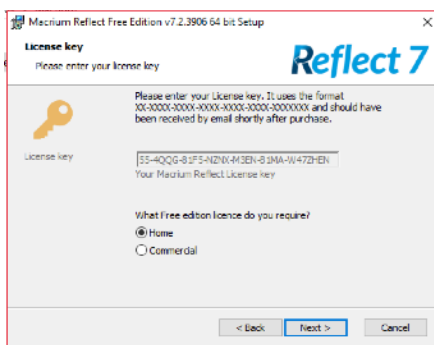
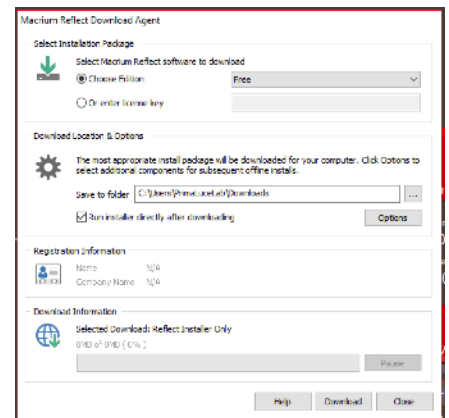

Once installed, it will automatically launch the Macrium Reflect software, and you will see this window (left). Please press the Next button to proceed.

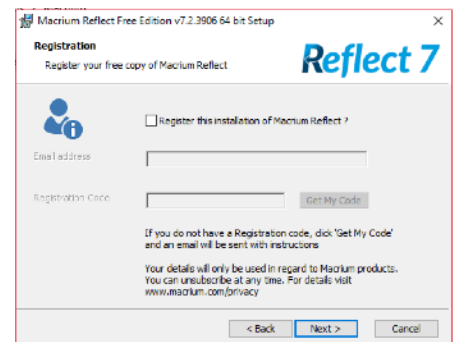

A new window will open, you can deselect “Register the installation of Macrium Reflect” and press Next button to proceed.

**NOTE: Before starting the backup of your SSD drive, please connect a USB 3.0 pen or an external USB 3.0 drive (with enough capacity to make the backup of your SSD drive) in one of the USB 3.0 ports of the EAGLE. Slower USB 2.0 pen or drive will also work but will need a longer time to perform the backup.**

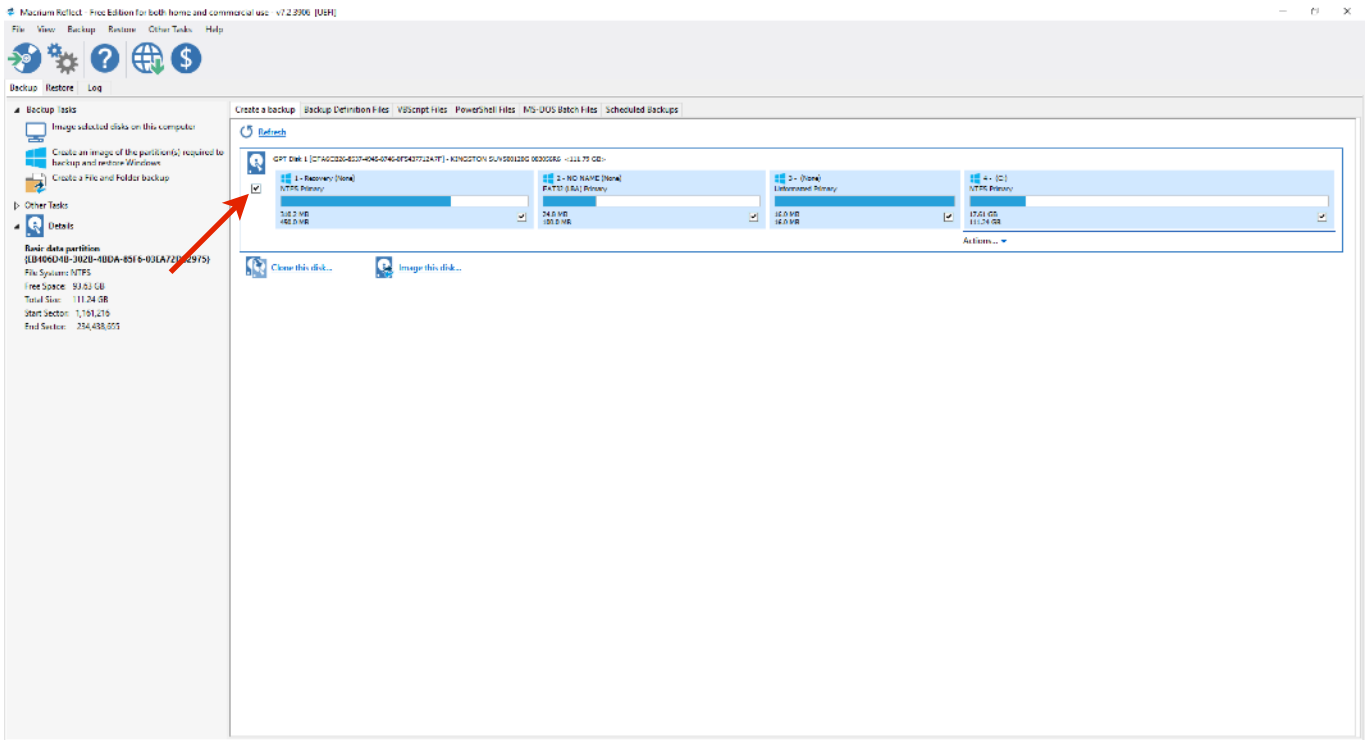

Macrium Reflect will start and you'll see a detailed list of the disks of your EAGLE. Select the SSD disk of the EAGLE (the first line) by checking the leftmost box option and click "Image This Disk".

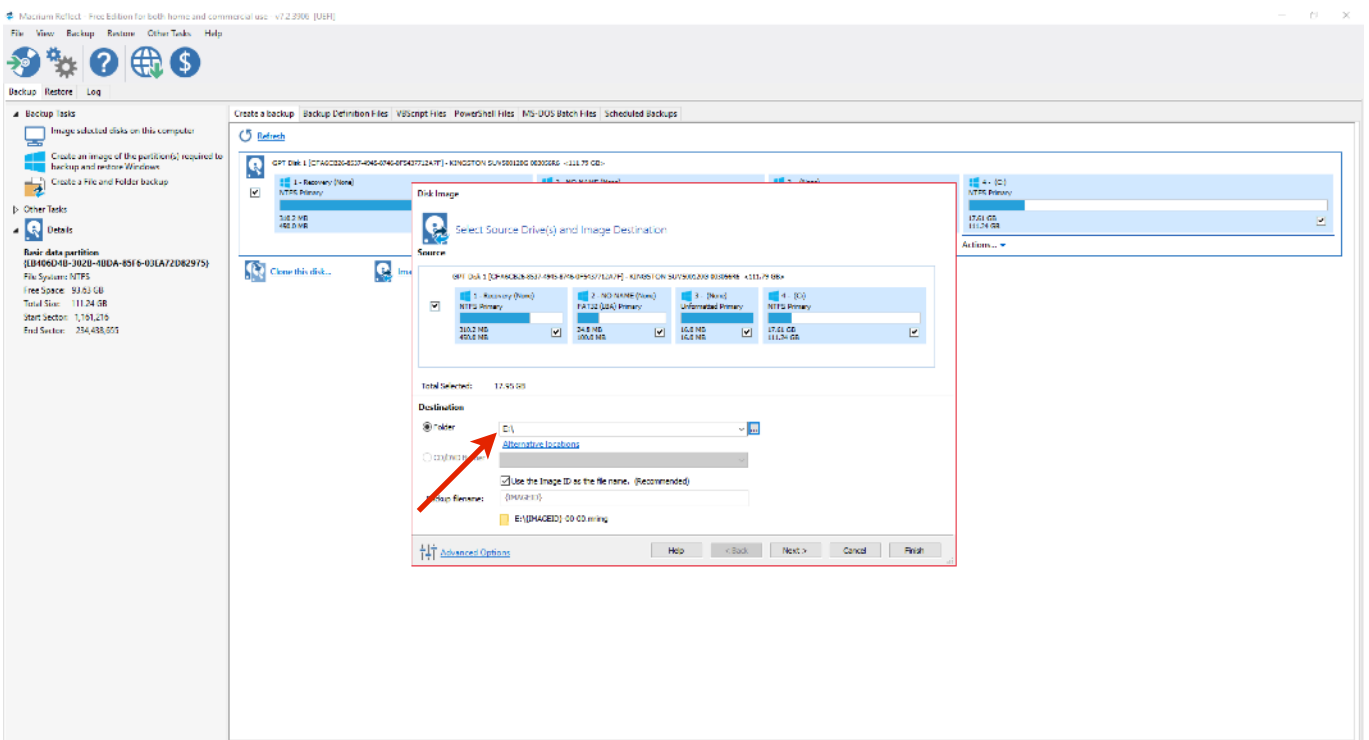

In the next window, choose your destination disk (the one that will house your SSD copy). Note that this will erase all data on the disk, so be careful which one you choose.

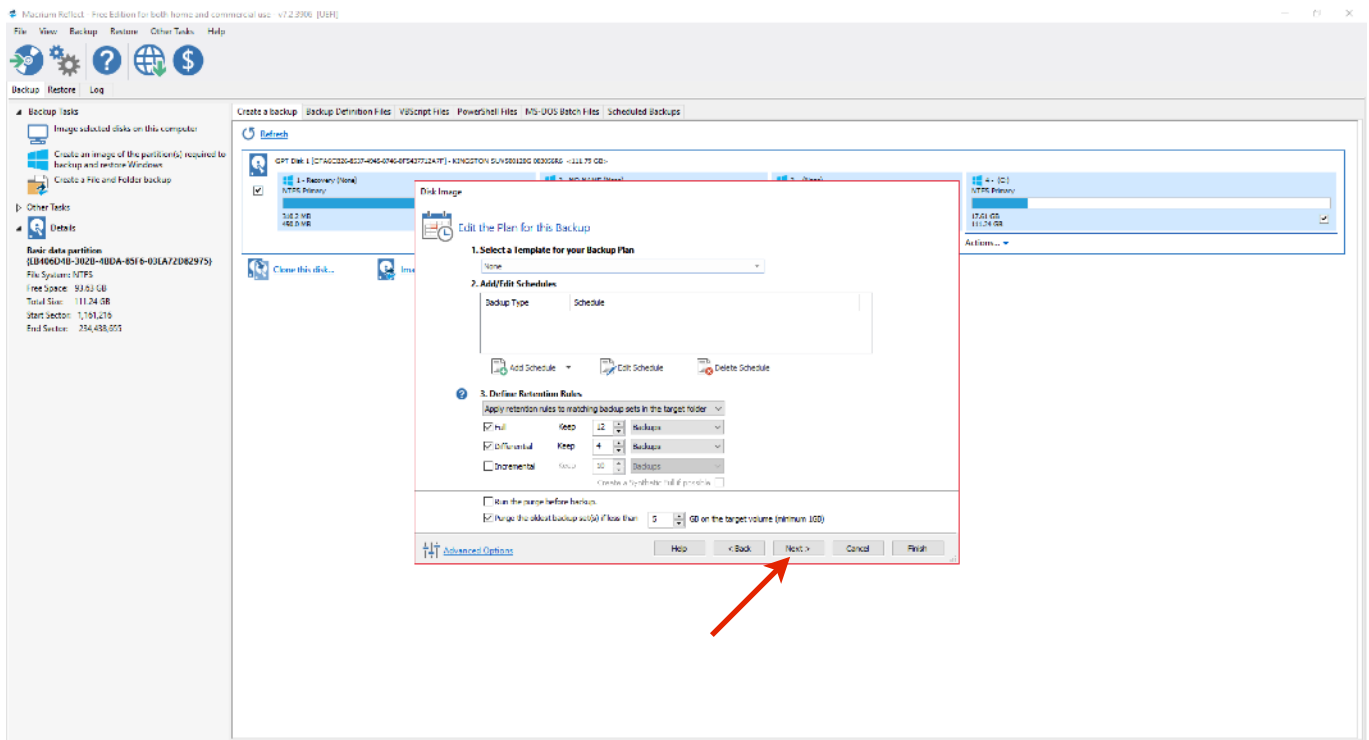

In the next window, please leave the options as they are and press Next to continue.

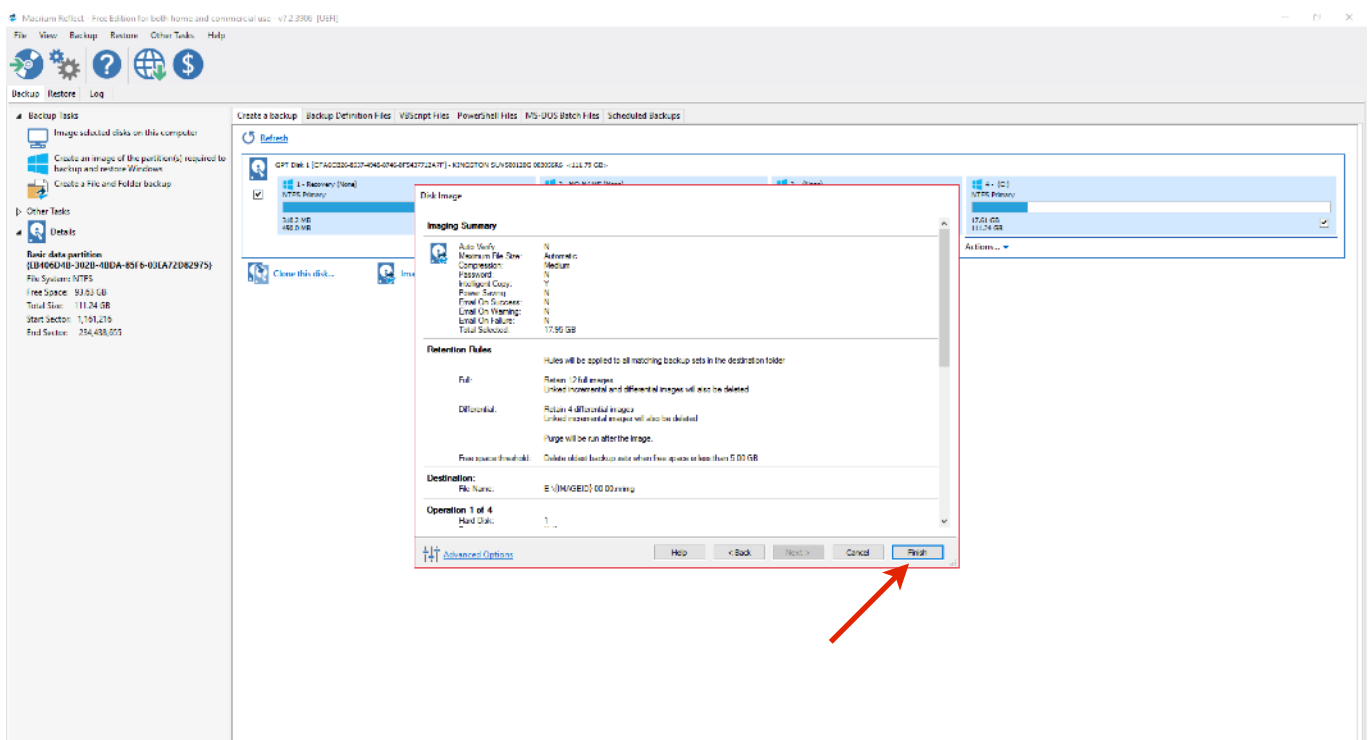

In the next window, please press Finish button finish the backup wizard.

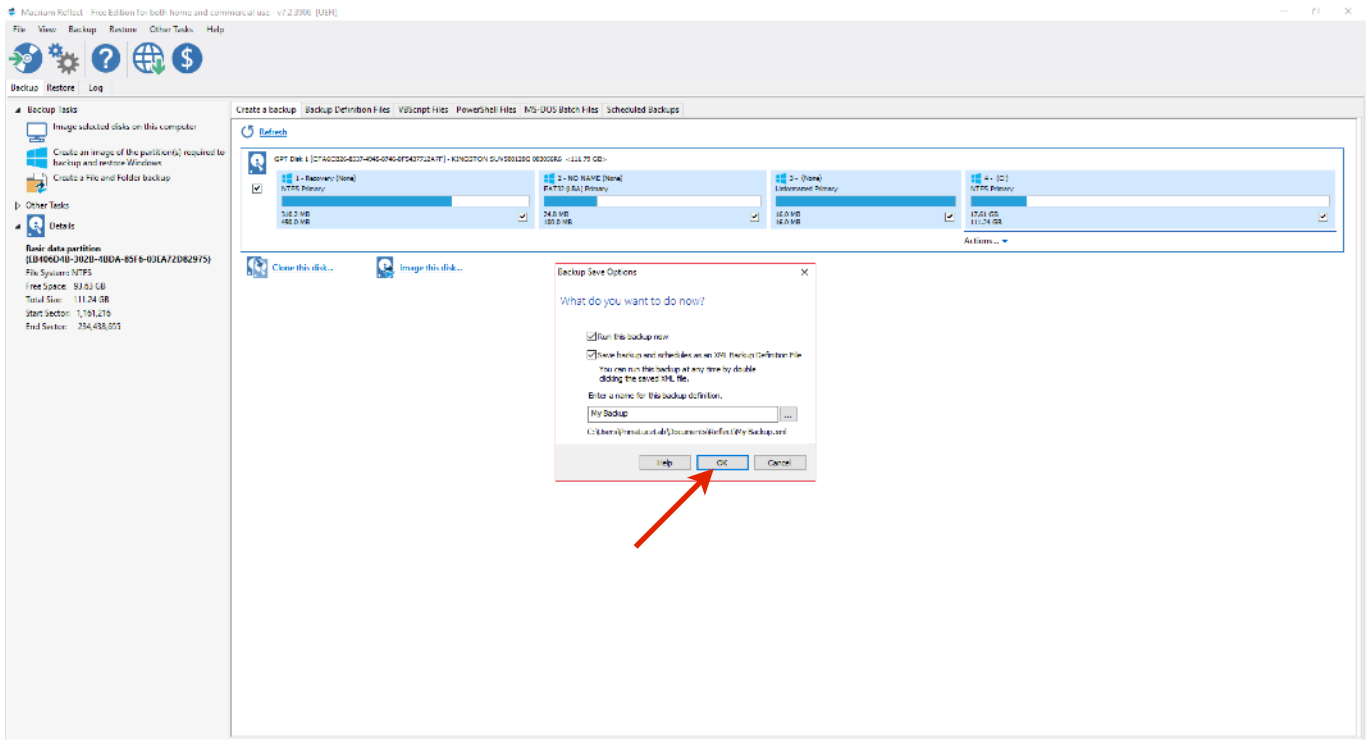

In the next window, please press OK button to start the backup of your SSD drive.

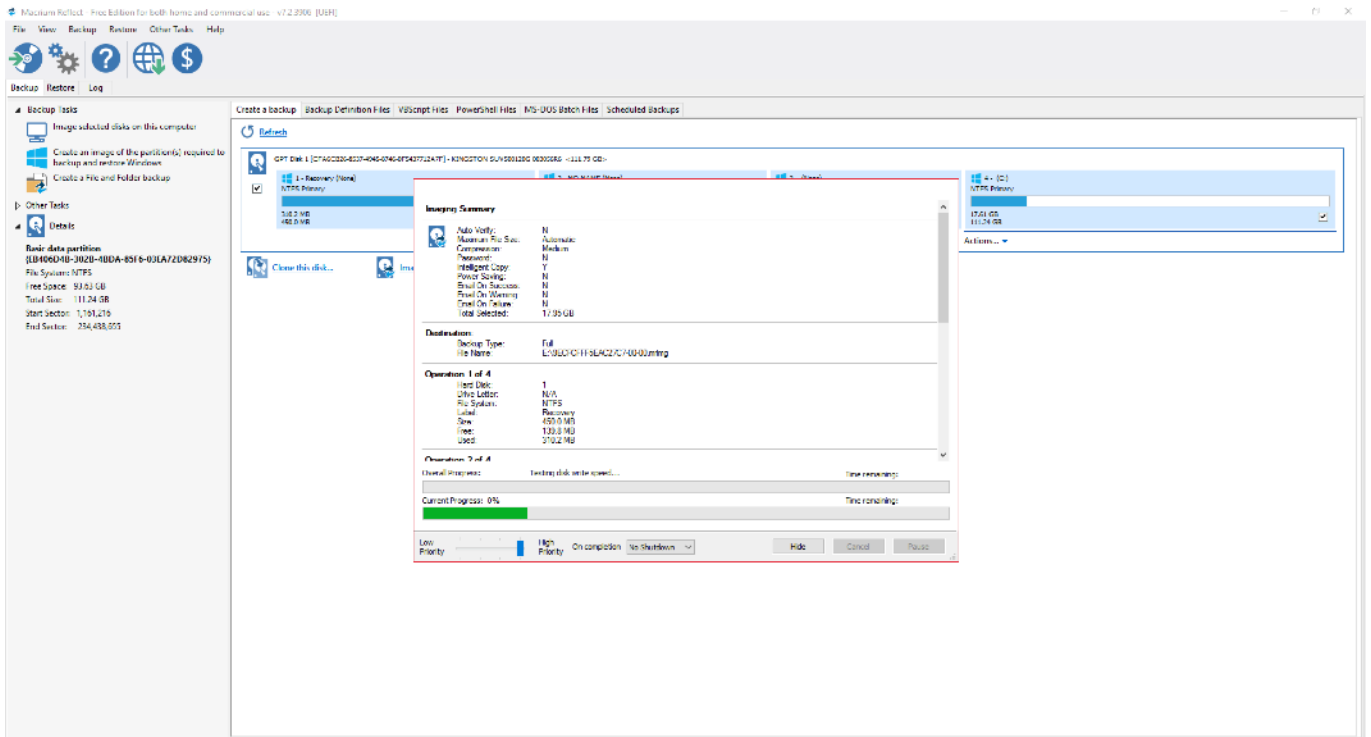

Finally, Macrium Reflect will begin the cloning process. This can take some time depending on the size of your SSD unit and on the speed of the USB pen or drive you use to make the backup, so give it time to do its thing.

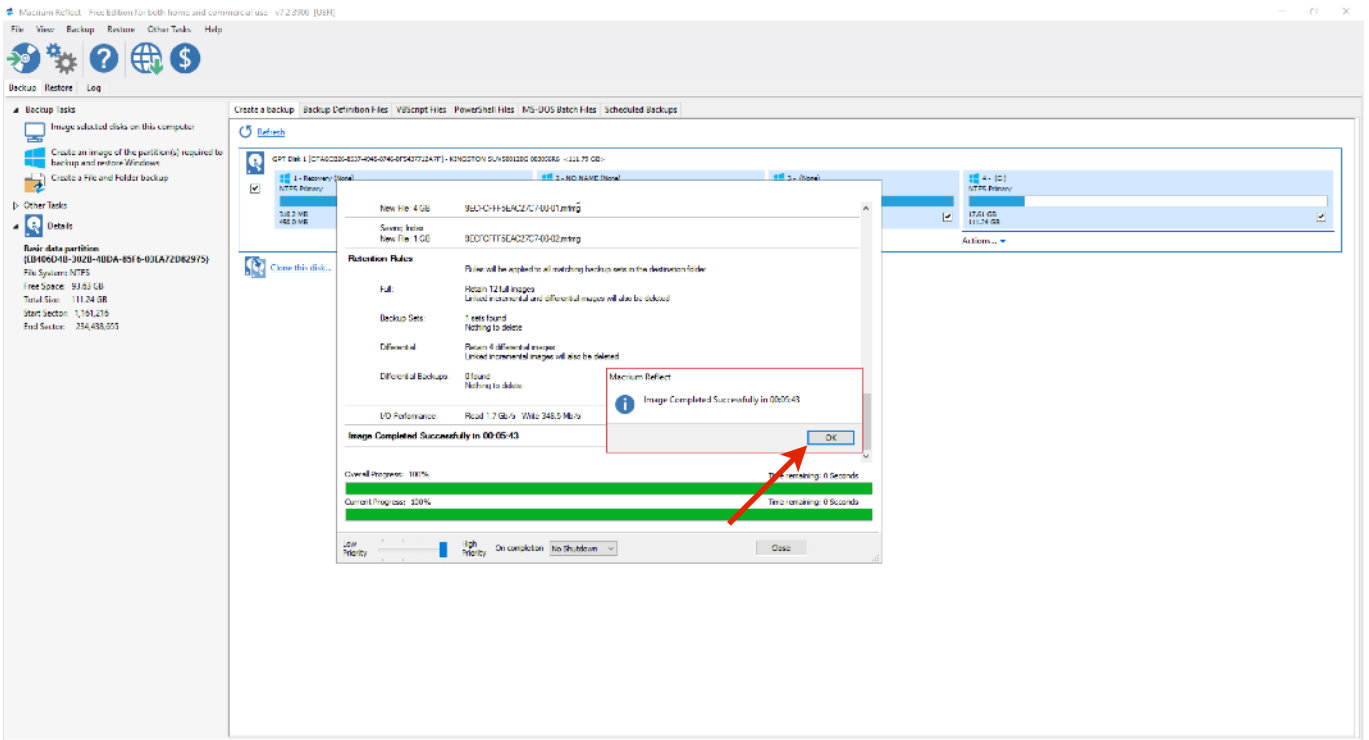

At the end of the procedure, you will get a confirmation message. You can press OK and exit from Macrium Reflect and disconnect your drive from the EAGLE. Now you have a full backup copy of your SSD drive that you can use if you will have troubles with Windows in the future. In order to use this backup, just reconnect the external drive in the EAGLE, start Macrium Reflect and select the “Restore” option on the left of the window.

**TIP:** Macrium Reflect allows you to restore your SSD backup copy only under Windows and this means that, if you lose your Windows operating system for any cause, you won't be able to start Macrium Reflect. In this case we also suggest you to create a Macrium Reflect rescue media on USB stick. This contains a lightweight version of Windows with a full version of Macrium Reflect and it allows you to use your SSD backup copy also if Windows won't boot.

In order to do this, insert a USB stick in one of the USB 3.0 ports of your EAGLE, then start Macrium Reflect, on the left select the “Backup” tab, then select “Other Tasks” and click “Create bootable Rescue media”. Please follow the on screen instructions to create the bootable USB stick and, if requested, confirm that the USB stick will be formatted (all the data in the USB stick will be erased).

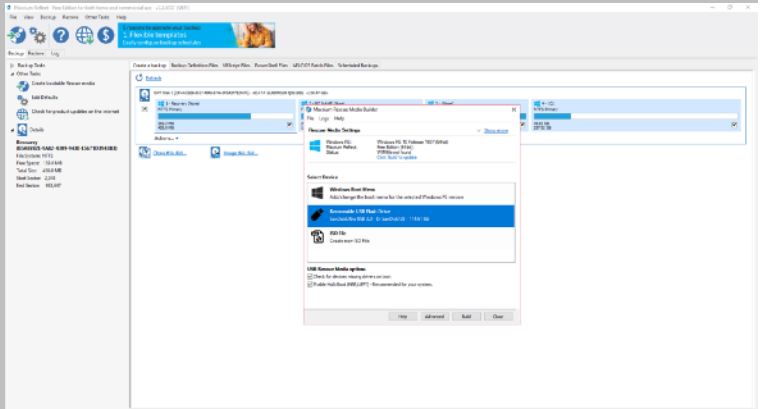

In order to use the bootable USB stick (in case your Windows can't boot properly), insert the bootable USB stick in your EAGLE, press the power ON button (the EAGLE has to be connected to an HDMI monitor with USB mouse and keyboard) and press the F10 button of your keyboard to select the bootable device. Select the USB stick and follow the on screen instructions to recover from the SSD image you previously created.



## First use: install your software

EAGLE uses a Windows 10 64 bit operating system. This way you are free to install the astronomy software you choose, as long as it is designed to work with 64 bit Windows 10. In order to install your software, you can proceed in 2 ways:

- A) *Connect the EAGLE to an HDMI monitor and add a USB keyboard and mouse.* This way you will be able to use the EAGLE as a standard desktop computer (picture 29) and install your software.
- B) *Connect your device (that you use to remotely control the EAGLE, for example a smartphone, a tablet or a computer) to the EAGLE with WiFi and start your Remote Desktop client* to see EAGLE's desktop and install your software.

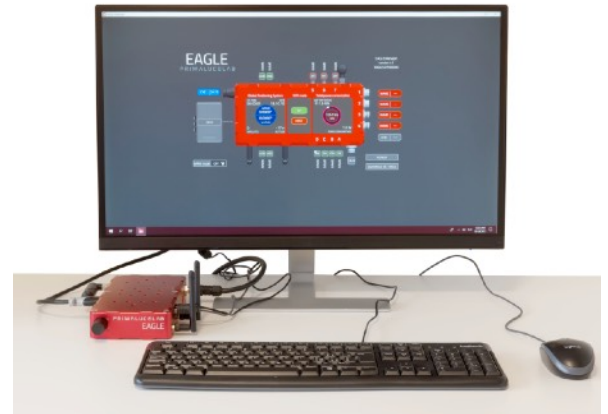

Image 29: EAGLE4 connected to HDMI monitor

Please note:

- 1) EAGLE does not have an integrated CD or DVD reader. If you have to install software that comes on CD or DVD, you may connect the external CD or DVD reader to the USB port of EAGLE. Then insert the CD or DVD of your software and follow the on-screen instructions to complete the installation.
- 2) If you have software to install from a USB thumb drive: connect the USB stick to the USB port of the EAGLE and follow the onscreen instructions to complete the installation.

For a better management of your software and to get quick access to frequently used applications, you can add your software to Windows "START" menu. In order to do this, select your software, make a right mouse click, then select the option "Pin to Start". The icon of your software will appear in the start menu that appears when you press the button on the screen bottom left (picture 30).

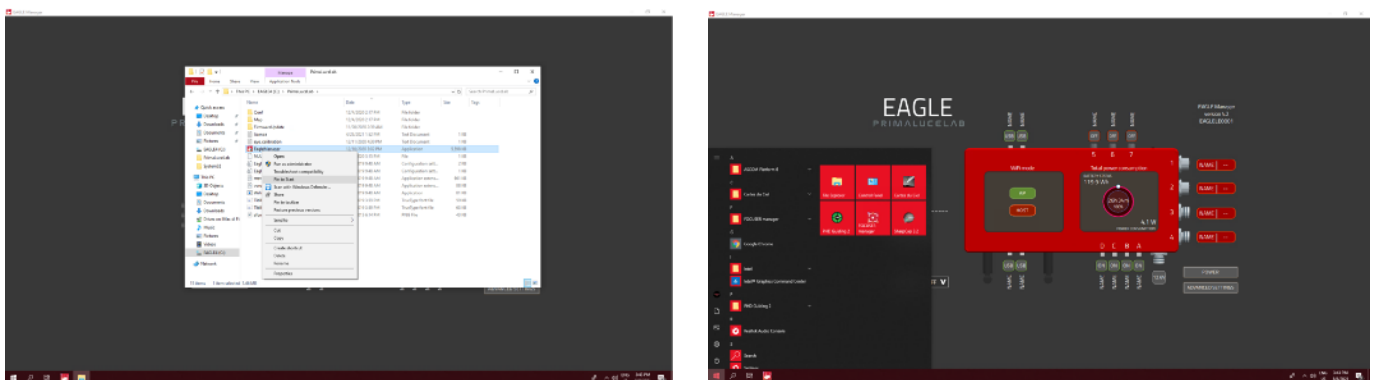

Image 30: In Start you find your software's icon

## First use: turn off EAGLE

When you want to turn off EAGLE, first disconnect your remote control device. From the START screen, select the "options off" and then press "Disconnect" (picture 31).

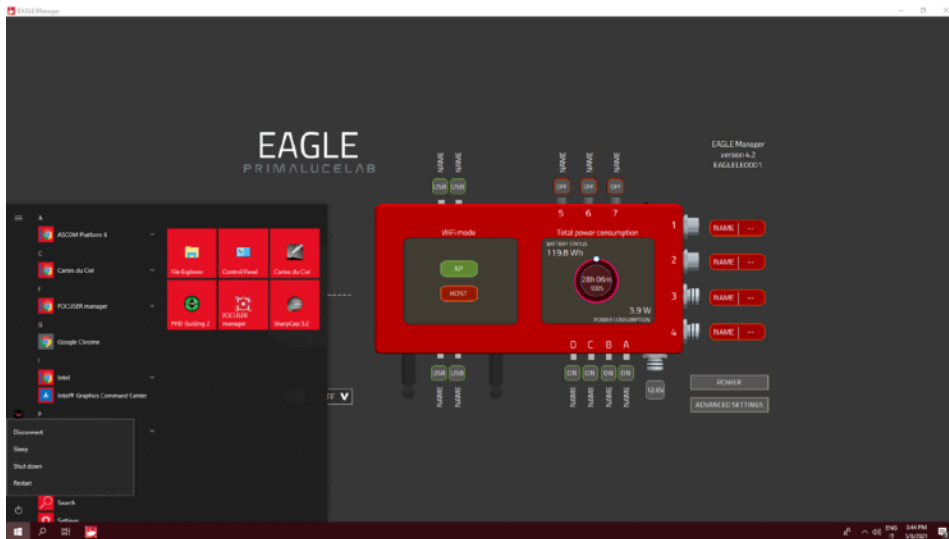

Image 31: Select "Disconnect" to terminate session

This way you can close the remote connection of your device. You can then close the "Remote Desktop" app. Then press the power button (7 - picture 32). Take a look at the LED to the left of the 4 USB 2.0 ports: when the SSD and ON LEDs will be off, you can disconnect the power supply.

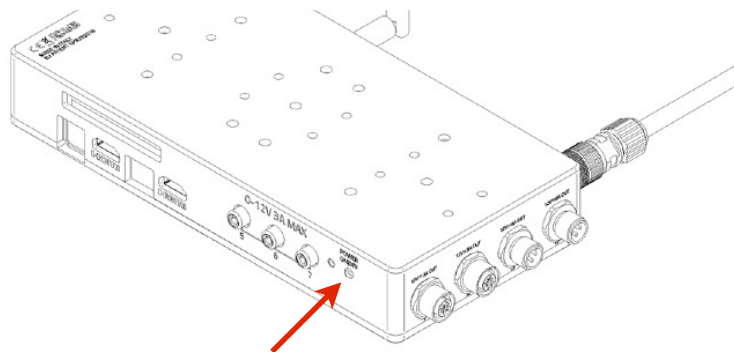

Image 32: push the ON / Off button (7) to switch EAGLE off.

**NOTE:** if you want to turn off the EAGLE remotely, you can press the POWER button in the EAGLE Manager interface. This will disconnect from the Remote Desktop app and will shut down the EAGLE.

## First use: installing EAGLE on the telescope

EAGLE has been designed entirely with SolidEdge three-dimensional design software to offer the best modularity with the PLUS elements (rings, dovetail plates or clamps) and/or any brand telescopes. EAGLE may be positioned between support and guide rings, connected to a Vixen or Losmandy style dovetail bar through the appropriate optional clamp or, in case of telescopes with long dovetail bars, it can be screwed on the PLUS Vixen or Losmandy dovetail bar and fixed over PLUS support rings. Let's explore the various possible configurations, depending on the telescope EAGLE has to be installed on, using both other PLUS elements and different instruments.

**CAUTION:** in order to connect EAGLE to other mechanical PLUS elements please avoid to use too long screws that may touch the internal electronics of the EAGLE. **THE THREADED PART OF THE SCREW THAT EXIT FROM THE ELEMENT (ring, bar or clamp) TO BE CONNECTED TO THE EAGLE HAS TO BE NO LONGER THAN 6mm.** If any of the screws touches the internal elements of EAGLE, this could lead to breakage or malfunction.

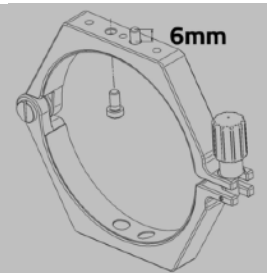

### Connecting to telescopes with PLUS support rings and support rings spaced up to 12cm.

When using compact refractor telescopes, the distance of the support rings is set by the PLUS Vixen or Losmandy style dovetail clamp installed with the telescope. In this case, the EAGLE can be installed directly above the support ring, as if it were a dovetail bar (image 33). Thanks to the M5 threaded holes present in the upper part of the EAGLE, you can install in parallel the PLUS guide rings and a guide scope (note: the guide scope must not exceed 5 kg in weight to avoid flexure).

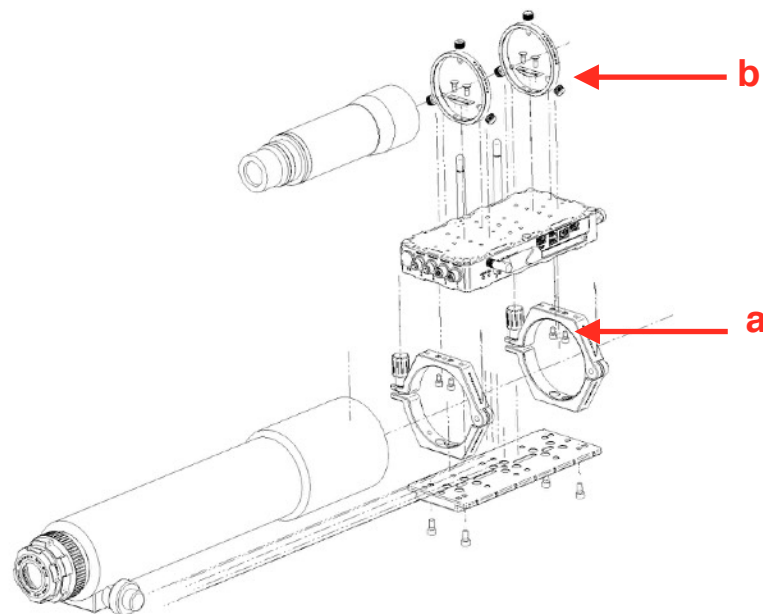

Image 33: installation of EAGLE between imaging and guide telescope



In order to use the EAGLE with this configuration, insert 2 M6 screws (a) in each PLUS ring (2 screws for each ring) and so fix the EAGLE. If you want to use a guide scope in parallel, you can install the PLUS guide rings. In order to do this, screw 2 M5 screws for each guide ring in the upper part of EAGLE (b).

**Connecting to telescopes provided with PLUS support rings and support rings spaced more than 12cm.**

If you want to use EAGLE with telescopes equipped with rings PLUS spaced more than 12cm, you can place EAGLE over to the support ring for supporting a compact guide scope in parallel. But to do so you first need to add a PLUS Vixen or Losmandy style dovetail bar above PLUS support rings and then connect EAGLE (image 34).

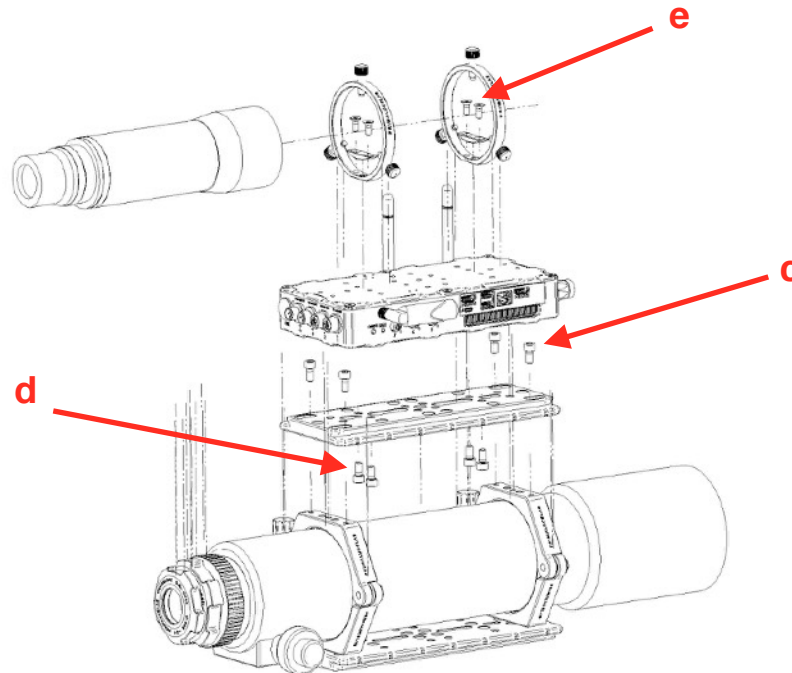

*Image 34: installing the EAGLE when the main telescope support rings are spaced more than 12cm*

In order to use the EAGLE with this configuration, use a PLUS Vixen or Losmandy style dovetail bar (with the same length as the one used under the support rings) and fix it with two M6 screws (c) for each ring. The dovetail bar above the telescope must be fixed in inverted position with respect to the one placed below the optical tube. Then use 4 M6 screws (d) to fix the EAGLE to the dovetail bar. Finally if you want to use a guide scope in parallel, you can install the PLUS guide rings. In order to do this, screw 2 M5 screws for each guide ring in the upper part of EAGLE (e).

**Connecting to telescopes not equipped with PLUS rings**

If your telescope is not equipped with PLUS support rings, just add the optional "PLUS Vixen + Losmandy style dovetail clamp" that can be screwed directly to the EAGLE and allow you to connect it to any Vixen or Losmandy style dovetail bar also from different brand. Take the "PLUS Vixen + Losmandy dovetail clamp" and, using 3 M6 screws (f), install it in the bottom plate of EAGLE, as shown in image 35.

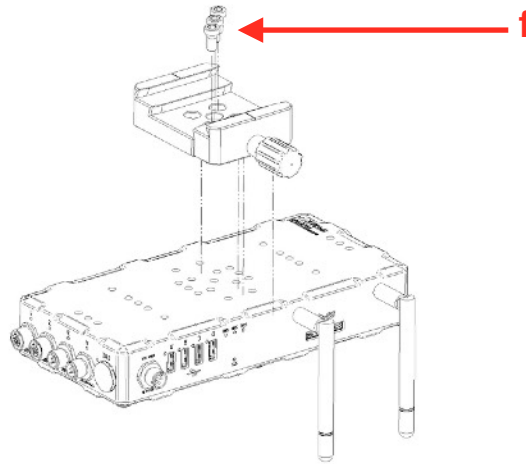

Image 35: installation of "Vixen+Losmandy PLUS dovetail clamp" on EAGLE

This way you can connect the EAGLE to any telescope equipped with Vixen or Losmandy style dovetail bar, as shown in image 36.

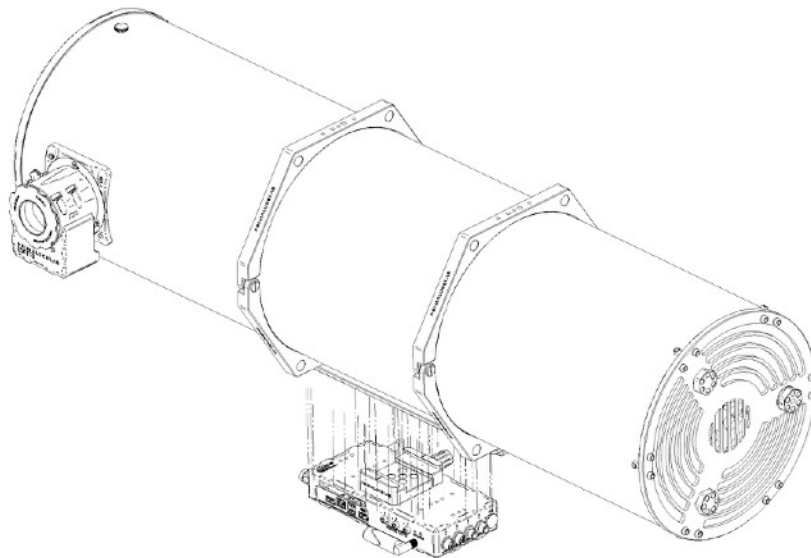

Image 36: EAGLE with "PLUS Vixen + Losmandy dovetail clamp" can be installed on any Vixen or Losmandy style dovetail bar

## First use: powering other instruments connected to the EAGLE

EAGLE incorporates a power bridge to which you can connect up to 4 instruments such as mount, camera, filter wheel and electronic focuser. Through a special internal board, EAGLE **distributes** 12V power to 4 ports that connect the various devices using the special optional cables. All ports are indexed and threaded to prevent the cable from unwanted disconnections or reversed polarity.

**CAUTION:** EAGLE distribute power only at 12V. If the instrument you want to use requires a different voltage, do **NOT** connect it to the power ports of EAGLE.

**CAUTION:** the power output from the OUT port of EAGLE depend on power supply or battery connected to the IN power port of the EAGLE. **Since several instruments for astronomy strictly require a fixed 12V power, you have to check that your power source provides a stable 12V voltage.** So if you want power EAGLE with a battery, make sure that this is equipped with a specific 12V voltage regulator. **DO NOT CONNECT TO THE EAGLE A BATTERY WITHOUT 12V VOLTAGE REGULATOR** since it may damage the other instruments powered by EAGLE ( like the cooled camera or the mount).

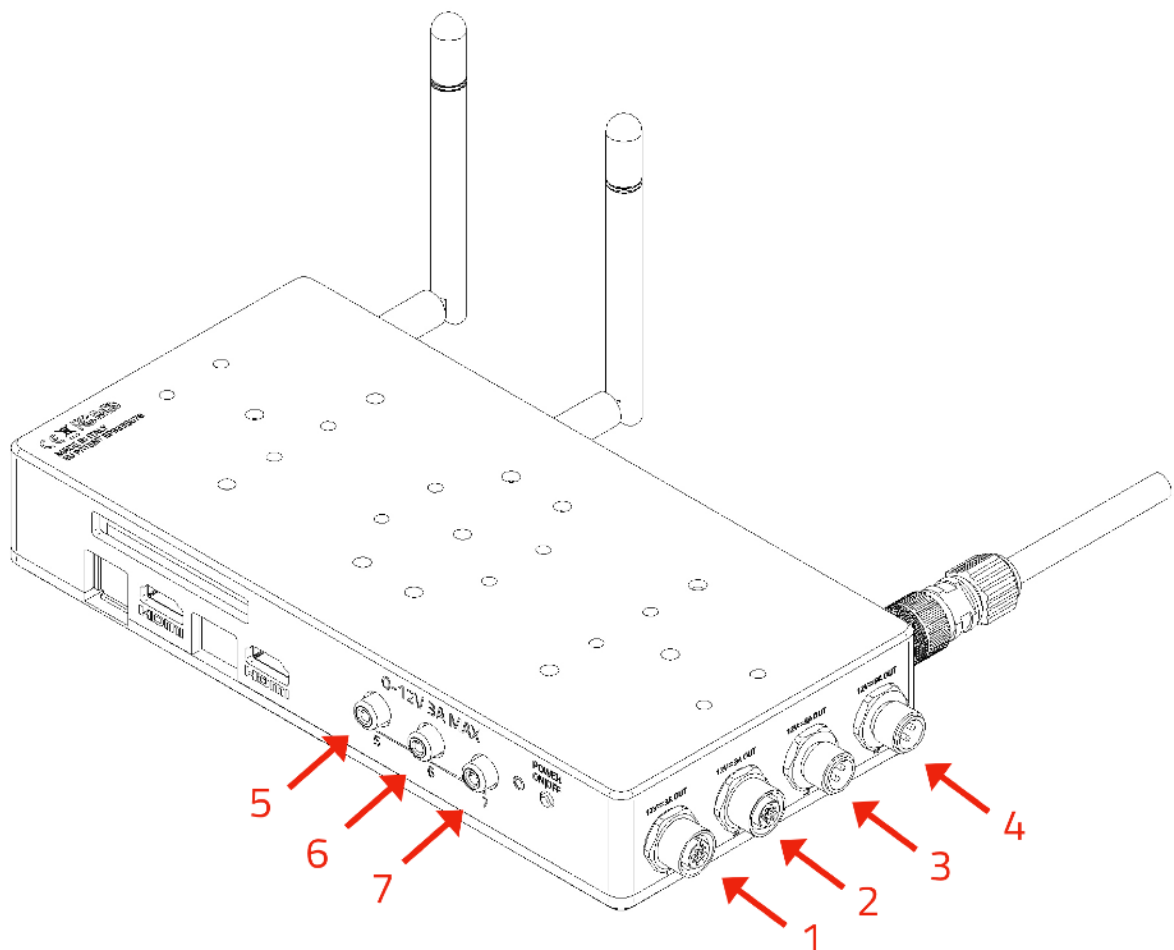

*WHAT IF I CONNECT A DEVICE THAT HAS A HIGHER POWER CONSUMPTION THAN THE ONE ALLOWED ONE FROM THE POWER OUT PORTS OF THE EAGLE : the power board has a dedicated chip that protects the electronics. If your device requires more current than the one distributed by EAGLE, this chip disconnects power (this is a protection system to avoid power surges that could damage the connected instrument).*

***In this case, please remove the cable connected to the power OUT port of the EAGLE. Power out port will be automatically re-activated when the problem is fixed.***

EAGLE has 7 12V power out ports including:

- **1, 2, 3 and 4** power out ports have 12V voltage. Ports 1 and 2 distribute up to 3A each while ports 3 and 4 distribute up to 8A and are therefore indicated for connecting high-power consumption devices (such as cooled cameras). In order to avoid confusing the connection ports, ports 1 and 2 (3A) have a different connector than the others. This makes it impossible to connect devices to the wrong ports.
- **5, 6 and 7** power out ports have adjustable voltage from 3 to 12V. They are therefore perfect for connecting dew heaters (without the need for external controllers).

To properly power all the instruments connected to the EAGLE :

- 1) **FIRST** connect the optional EAGLE-compatible power cables to OUT power ports of the Eagle and then to the power socket of your instrument
- 2) **AFTER** connect the power supply or stabilised battery to the IN power port of the EAGLE

You can turn on the EAGLE, activate the power OUT ports and use the telescope. When you want to close the telescope and disconnect power cables, please follow this procedure :

- 1) **FIRST** turn off the EAGLE by pressing the power on/off button (7) and wait until the SSD and ON LEDs are off
- 2) **THEN** unplug the power cord from the "12V power input" (1) of the EAGLE
- 3) **FINALLY** disconnect the power cables from the " 4 12V power OUT" ports (10) of the EAGLE

## First use: remotely control devices with EAGLE Manager

When you remotely (with WiFi or Ethernet wired connection) connect to the EAGLE, you will see the EAGLE Manager control interface. Thanks to EAGLE Manager, you can:

- Enable/Disable every 12V power out port.
- Set the power out voltage of the 3 x 0-12V power out ports
- Activate DARK mode: this turns off all the LED lights
- Connect or disconnect devices connected to the four USB 2.0 ports
- Check power consumption and battery lifetime
- Set WiFi connectivity
- Set your automatic power routines

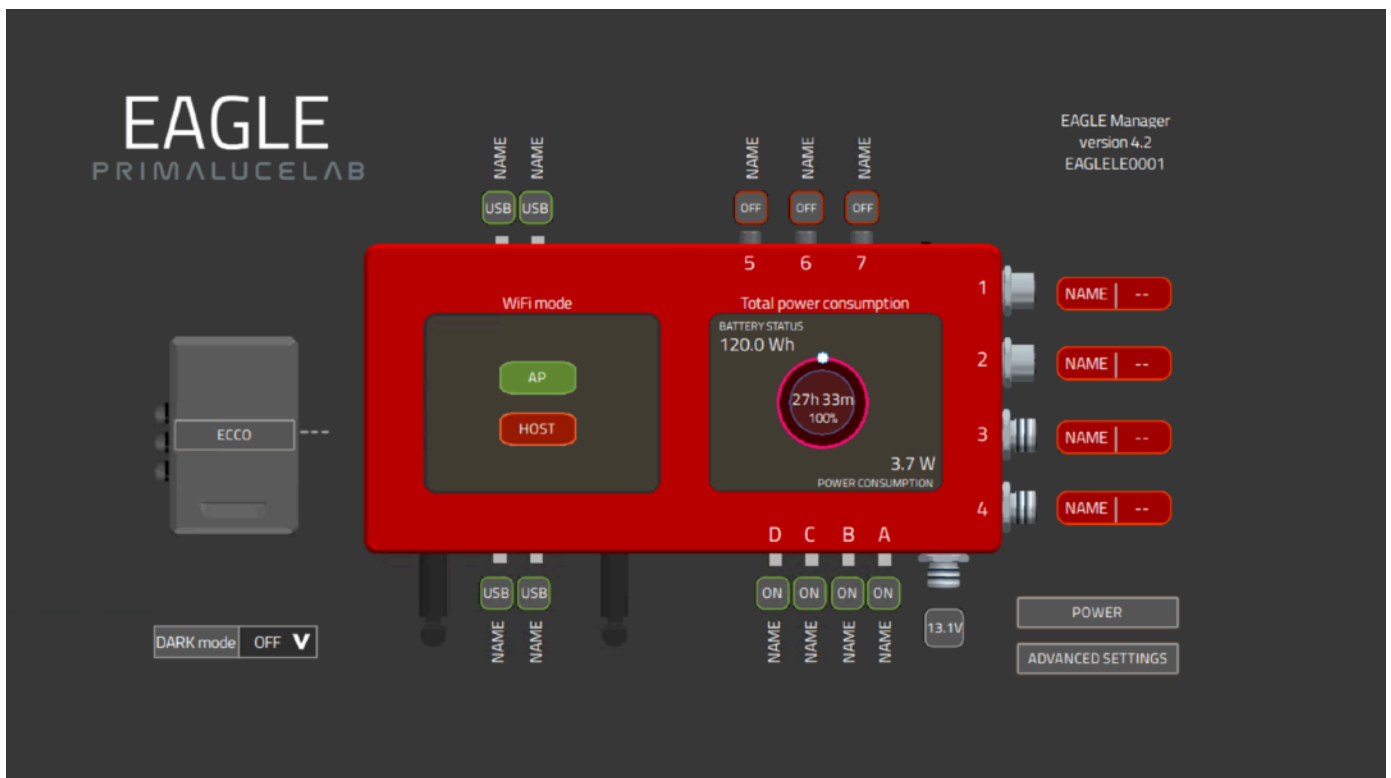

Image 37: EAGLE Manager interface

In the first window that appears (“Select power source”, image 38) please check your power source, with AC power units (5A or 14A) or with a battery. If you use a battery, please insert in the “Battery parameters” area to the right the battery capacity in Ampere and the charge status. Then click OK.

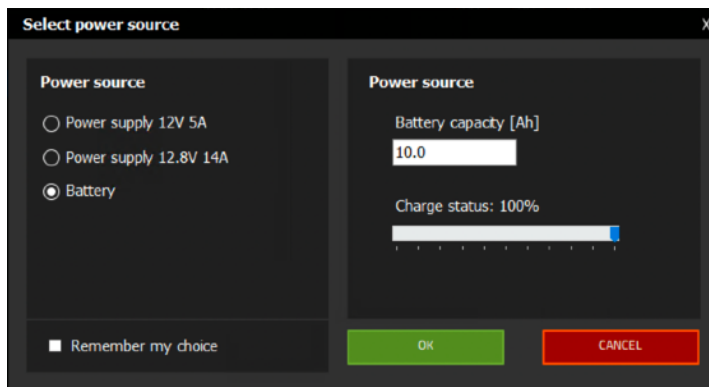

Image 38: setting the EAGLE power source

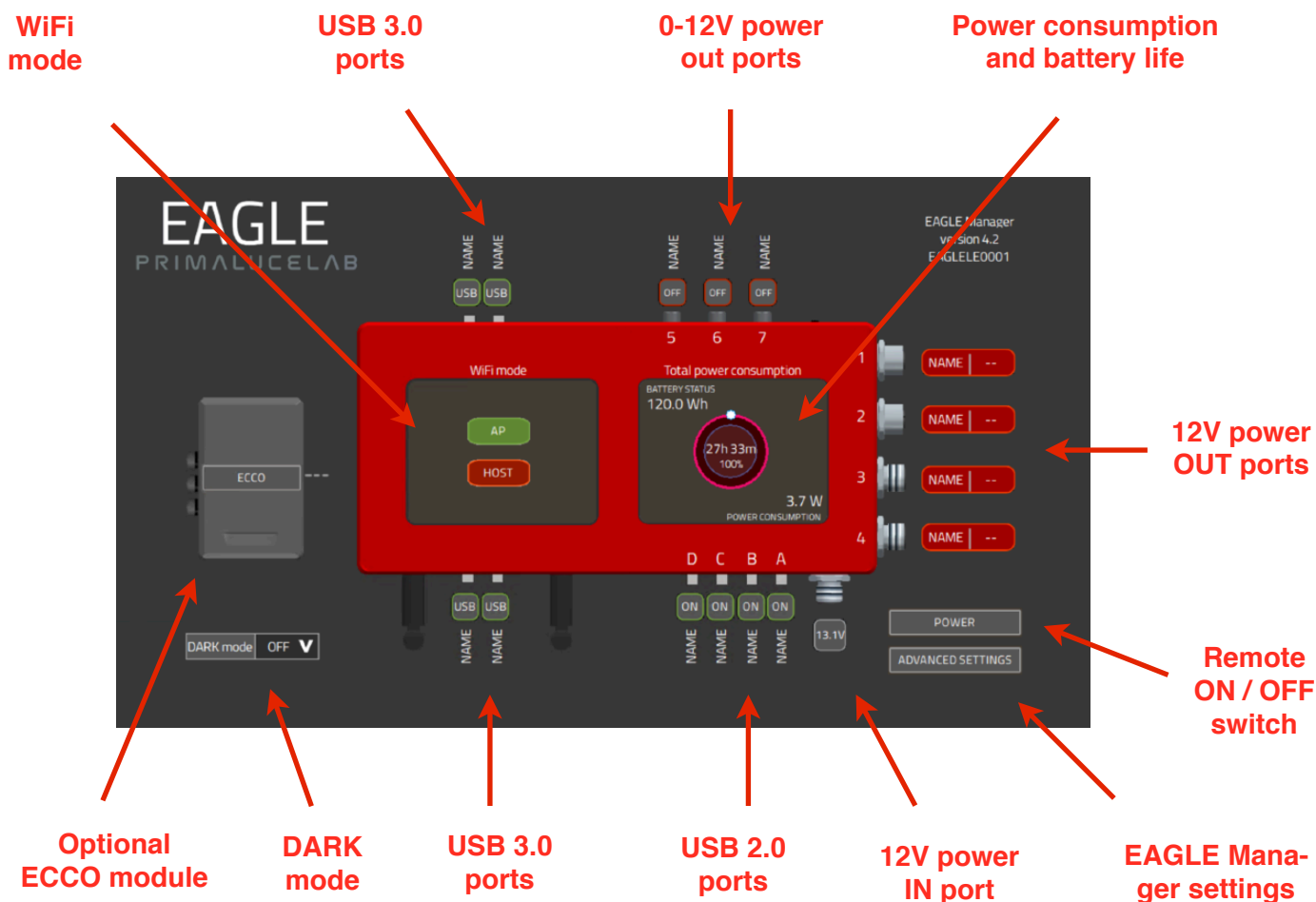

Image 39: EAGLE Manager interface

**- connect or disconnect every power out port of EAGLE**

Leaving power connected to your devices (for example, mount, camera, filter wheel, etc.) allows you to activate them remotely when you turn on the entire system. Each port shows the current consumption that can also be monitored over time.

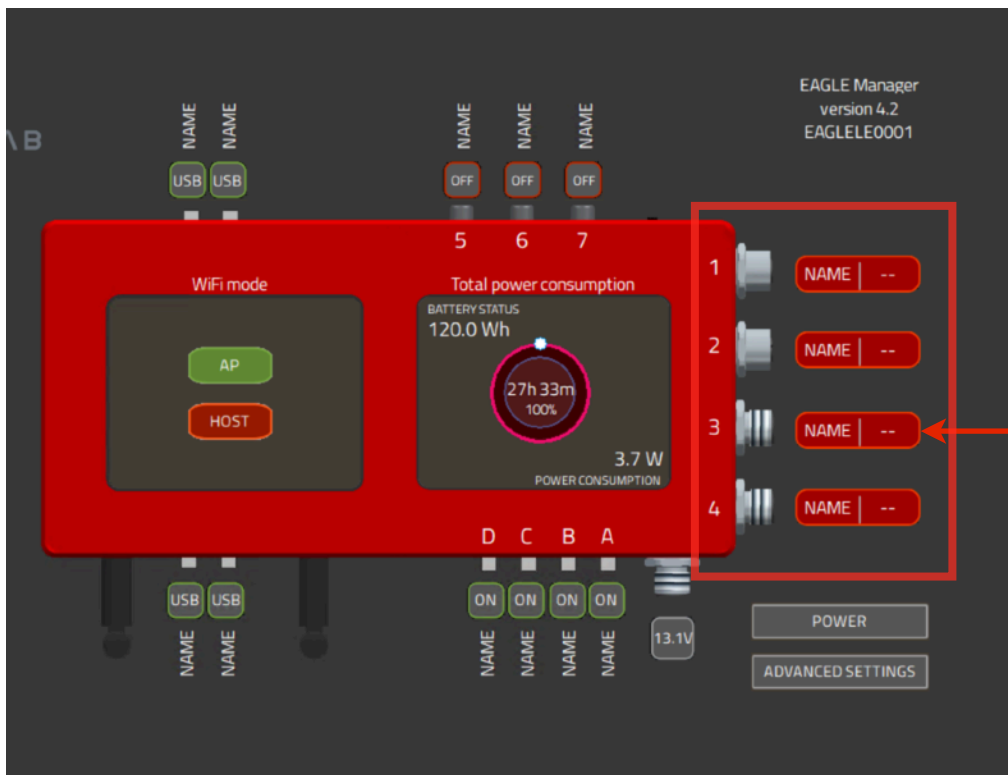

Image 40: click on one of the 4 power OUT ports to activate it

Click with the left mouse button (or a single tap on the screen of tablet or smartphone used for remote control) on one of the 12V power out ports to activate it, the port will become green and it will power the connected device. Click with the right mouse button (or a 2 finger tap on the screen of tablet or smartphone used for remote control) on one of the 12V power out ports to see advanced options of the selected power out port (image 41).

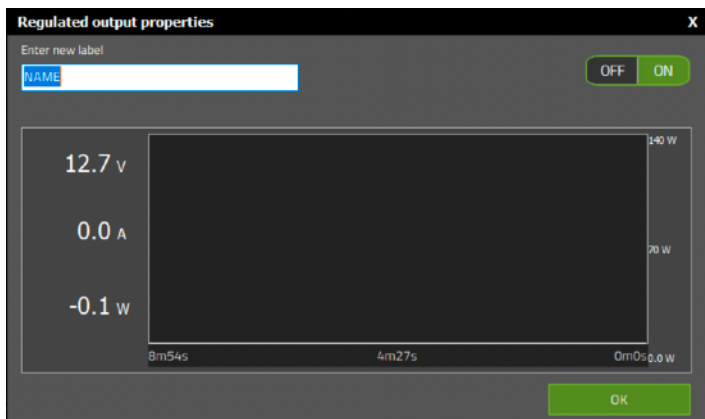

Image 41: advanced options window of one of the 12V power out ports

Here you can insert the name of the port in the field "Enter new label", check for power consumption of the connected device and check for power consumption (Watt) in time. Click OK button to confirm and exit from the window.

**- set power out voltage of the 3 power out ports with adjustable voltage**

For example, you can increase or decrease the heat generated by dew heaters connected to EAGLE without the need for external controller. Each port shows the current consumption that can also be monitored over time.

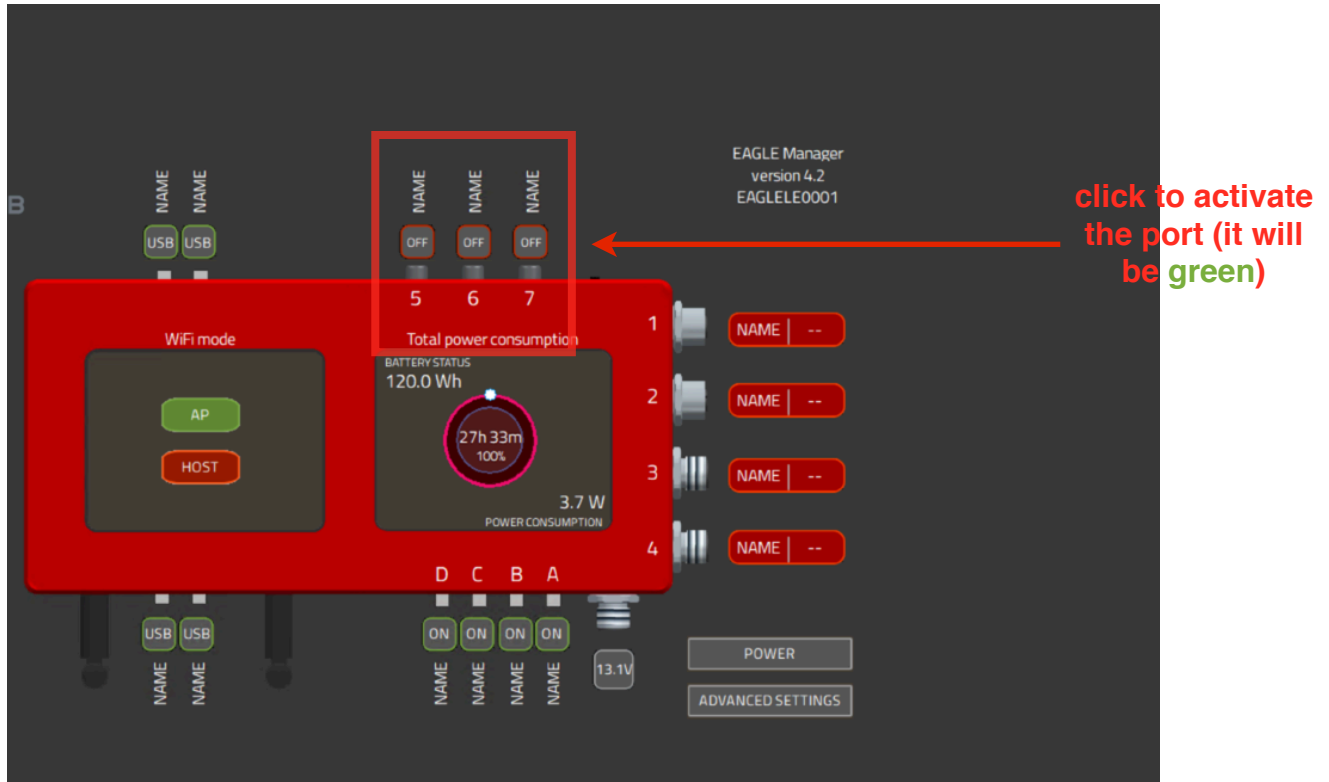

Image 42: click on one of the 3 power out ports to activate it

Click with the left mouse button (or a single tap on the screen of tablet or smartphone used for remote control) on one of the power out ports to activate it, the port will become green and it will power the connected device. Click with the right mouse button (or a 2 finger tap on the screen of tablet or smartphone used for remote control) on one of the power out ports to see advanced options of the selected power out port (image 43).

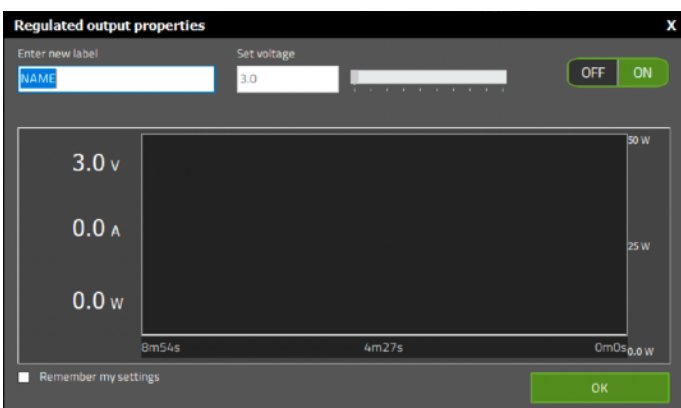

Image 43: advanced options window of one of the 0-12V power out ports

Here you can insert the name of the port in the field “Enter new label”, visualize power consumption of the connected device and the power consumption (Watt) in time. You can also set the voltage of the power out port in the field “Set voltage” (you can modified it only when the power out port is not active, it has to be in OFF state).

Click OK button to confirm and exit from the window.



**- connect or disconnect devices attached to the 4 USB 2.0 ports**

This feature is convenient in case of temporary crash of autoguider or planetary camera (or other devices), which can then be reactivated without the need to go to the telescope and disconnect/reconnect the cable.

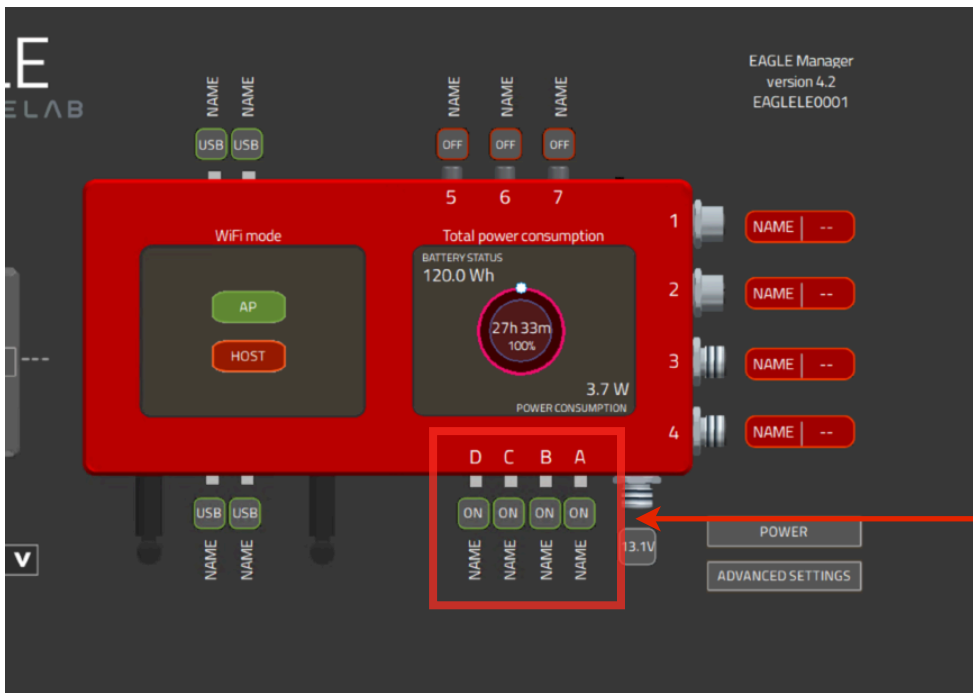

Click with the left mouse button (or a single tap on the screen of tablet or smartphone used for remote control) on one of the power out ports to activate it, the port will become green and it will connect the device. Double click on the NAME label to change its name.

**click to activate the port (it will be green)**

Image 44: click on one of the 4 USB 2.0 to activate it

**- check for power in voltage and battery lifetime**

if you power your EAGLE with a battery, a dedicated menu allows you to set the Ampere capacity of your battery and charge percentage when EAGLE is powered on, enabling you to monitor its expected lifetime.

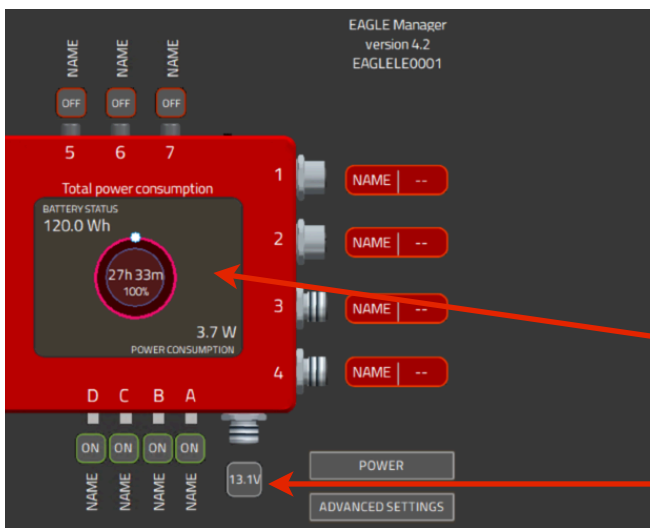

**battery lifetime**

**power IN voltage**

Image 45: power IN voltage and battery lifetime

**- set WiFi connectivity**

You can access the EAGLE in Access Point (AP) mode for field use (use your smartphone, tablet or external computer by connecting directly to EAGLE without the need of a WiFi router) or HOST mode for connecting to your existing network such as the WiFi network at your home.

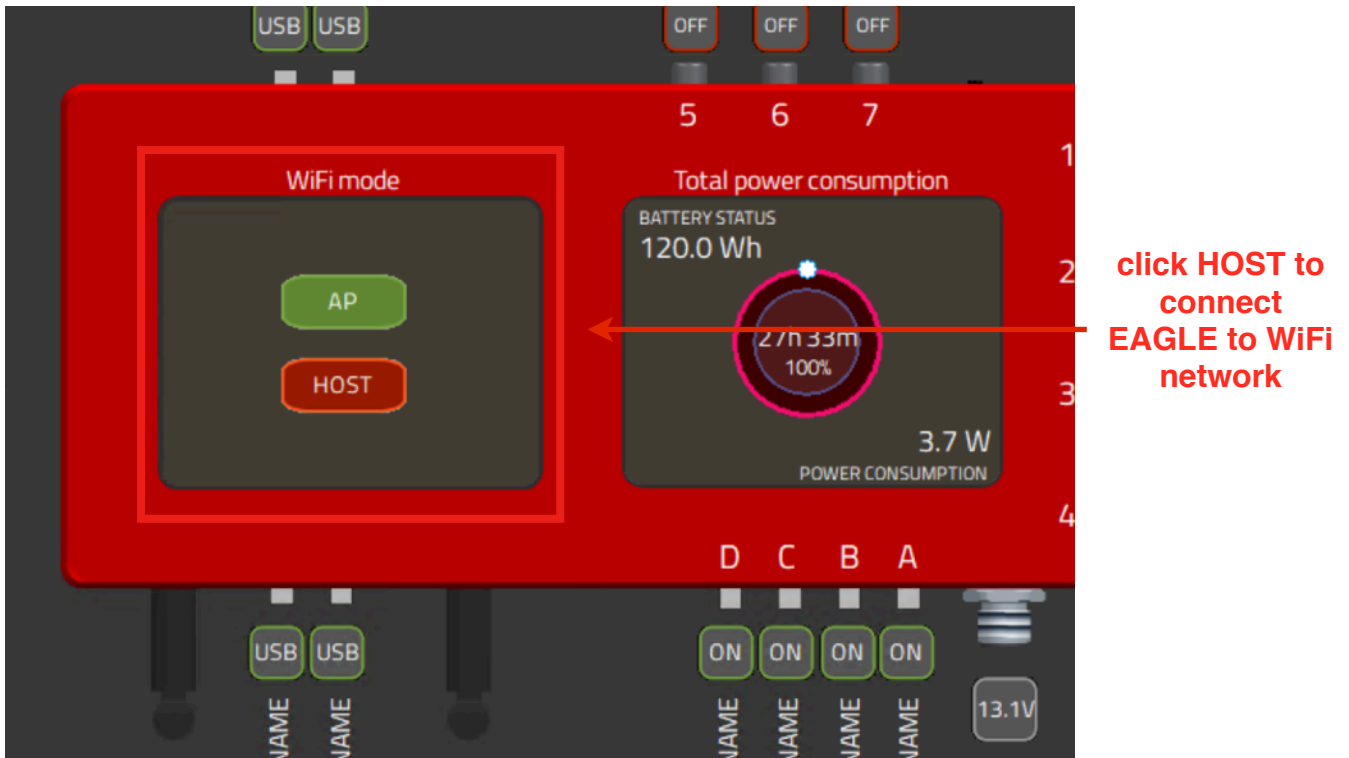

Image 46: WiFi connection settings

EAGLE activates the Access Point (AP) mode by default. If you want to connect EAGLE to a pre-existing WiFi network, click the ADVANCED PARAMETERS button to activate the advanced options window. Here, in the “HOST WiFi” area (Image 47), select the WiFi network that you want EAGLE to connect to and enter the network password. Then click OK to confirm. When you confirm the switch to HOST mode, you will lose the connection to the EAGLE. **In order to complete the settings, please connect the EAGLE to an HDMI monitor and connect an USB keyboard and USB mouse. This will be requested just for the first connection with the HOST mode.**

**select your WiFi network and insert password**

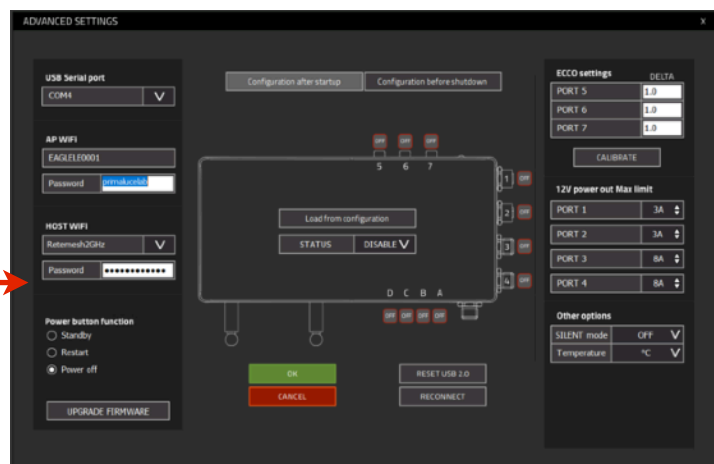

Image 47: insert access parameters to your WiFi network

**ATTENTION!**

**Make sure that you entered the correct network parameters (especially your network password) because, if they are wrong, EAGLE will not be able to access your network and at the same time it will not create its network in Access Point mode: in this case you won't be able to connect to EAGLE anymore and you will need to click its RESET button to reset the network.**

Now click on the HOST button to connect EAGLE to the previously set network. A popup window will appear asking you if you want to confirm. You can press OK button if you want to proceed.

Now you have to set remote access parameters in Remote Desktop software installed in the device you want to control EAGLE from. First of all you need to verify what is the IP address your router assigned to the EAGLE when you activated the HOST feature and this may vary based on your network configuration. In order to determine your IP address, in the EAGLE please type "cmd" in the "Search Windows" bar (bottom left part of the Window) and press ENTER in the keyboard. This will open a new window. Please type "ipconfig" and press ENTER again. You will see a line with the IP number of your EAGLE connected to your network (please take a look at the picture below). This is the IP number you have to write in Remote Desktop when you want to connect to EAGLE by using the HOST feature.

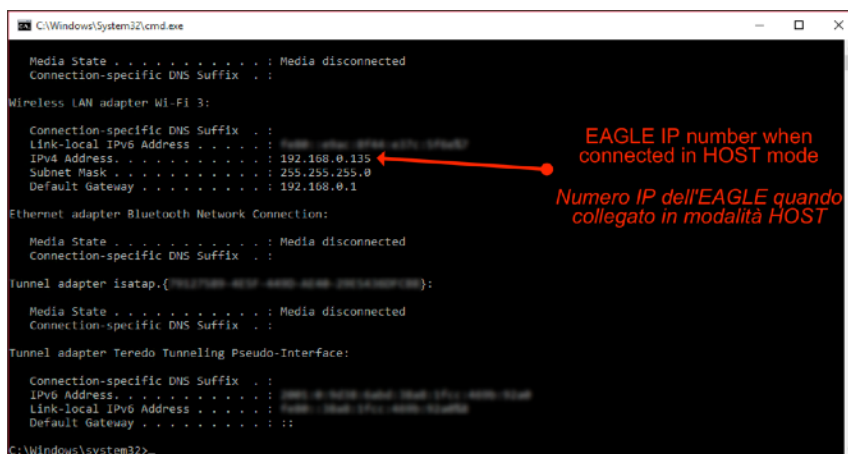

You have to insert this address in the options of "Remote Desktop" software (image 48) in the device you use to control the EAGLE from, instead of 192.168.137.1 as previously set. Click on Save to save software connection options. Going back to main page you will find a new connection. Connect your computer (or other device) you use to control the EAGLE from to the same WiFi network you connected EAGLE to and click on the new connection just created in the "Remote Desktop" software to start remote connection.

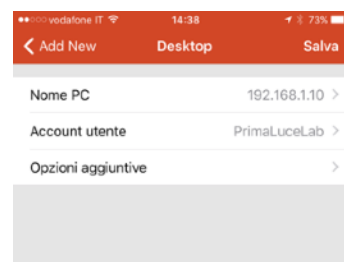

Image 48: Remote Desktop connection settings

**Tip: if during the use of the EAGLE you can no longer access to its WiFi network, both in AP or HOST mode, press the RESET button on the left of the POWER button on the EAGLE case. This will reset WiFi network in AP mode. Then, in the device you use to control EAGLE from, you have to select the WiFi created by the EAGLE (EAGLEXXXXX) and restart Remote Desktop.**

**- remotely turn on/off the entire telescope**

EAGLE has a standard ON/OFF button to turn on/off the unit but you can also turn off the whole system remotely. After switching on the EAGLE, the user can activate remotely connected devices and use the telescope. At the end of the capture, the user first turns off the various devices (camera, mount, etc.) and then the EAGLE.

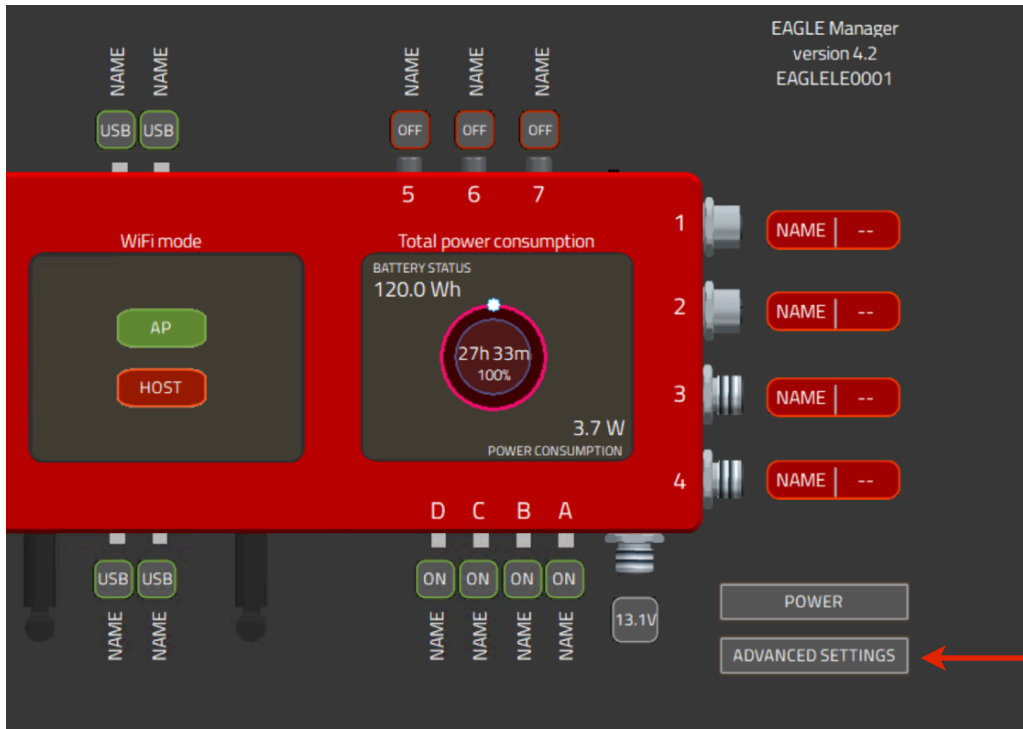

Image 49: ADVANCED SETTINGS button in EAGLE Manager

Press the ADVANCED SETTINGS button and, in the window that opens, you can set the switch ON/OFF setting you prefer for the POWER button of the EAGLE Manager software. In order to switch off the EAGLE when you press the POWER button, please select the “Power off” setting. You can also select the “Standby” mode (useful for remote power in when EAGLE is connected to a wired network, please see next paragraph) or “Restart” (to restart it). Click OK to confirm. To switch off EAGLE now you can press the POWER button.

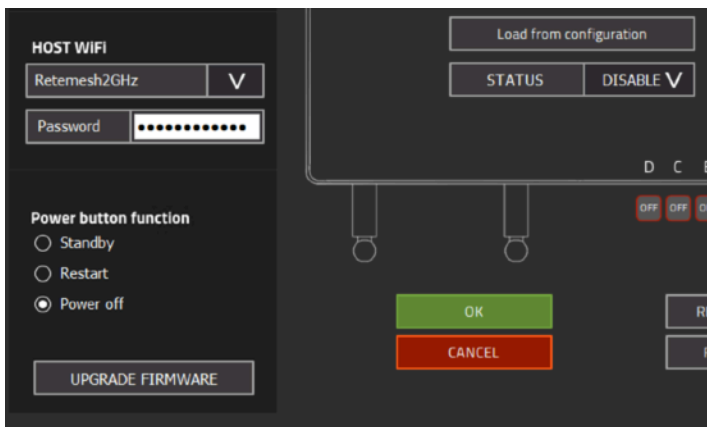

Image 50: ADVANCED SETTINGS window

**Tip: if, using EAGLE Manager and you are no longer able to control power out ports or USB ports of the EAGLE, go to ADVANCED SETTINGS and click RECONNECT button.**

### - change the password of the WiFi network created by EAGLE

By default, EAGLE generates a WiFi network with EAGLExxxxx name (where xxxx is the serial number of your EAGLE) as reported also in the front part of the EAGLE. Default password is **primalucelab** but you can change it for your safety.

This way, if you're using the telescope together with other EAGLE users, only you will be able to access to your EAGLE AP WiFi network.

In order to do this, please click the ADVANCED PARAMETERS button. In the WiFi area, you can see the WiFi network name created by your EAGLE ("AP WiFi"). You can modify the "password" field with the password you prefer and click OK to confirm (image 51). NOTE: The password has to be 8 characters long, it may contain both letters and numbers, without spaces.

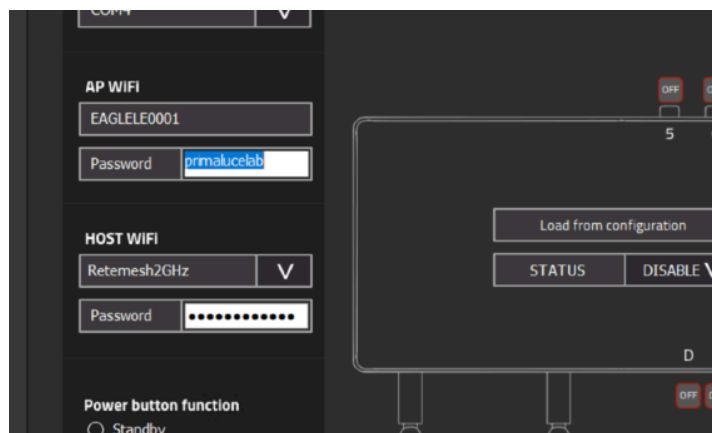

Image 51: ADVANCED SETTINGS window

#### NOTE!

- 1) after changing the password, you will need to access the WiFi network created by EAGLE again from your control device.
- 2) do not lose your password otherwise you will no longer be able to access EAGLE remotely.

## - DARK mode

DARK mode feature that allows you to instantly turn off all the LED lights on the EAGLE. Not only this will prevent any influence on your telescope but it is also a great feature for your astronomy friends that may be close to you while enjoying the night sky together. Thanks to the new DARK mode, the EAGLE is now a welcome guest at star parties where standard computers may be prohibited because of uncontrolled light emissions from LEDs and screens (the EAGLE doesn't need for a screen to operate). In order to activate DARK mode, please select ON in the bottom-left switcher of the EAGLE Manager interface. All the LED lights of the EAGLE will turn off and the EAGLE Manager interface will become darker.

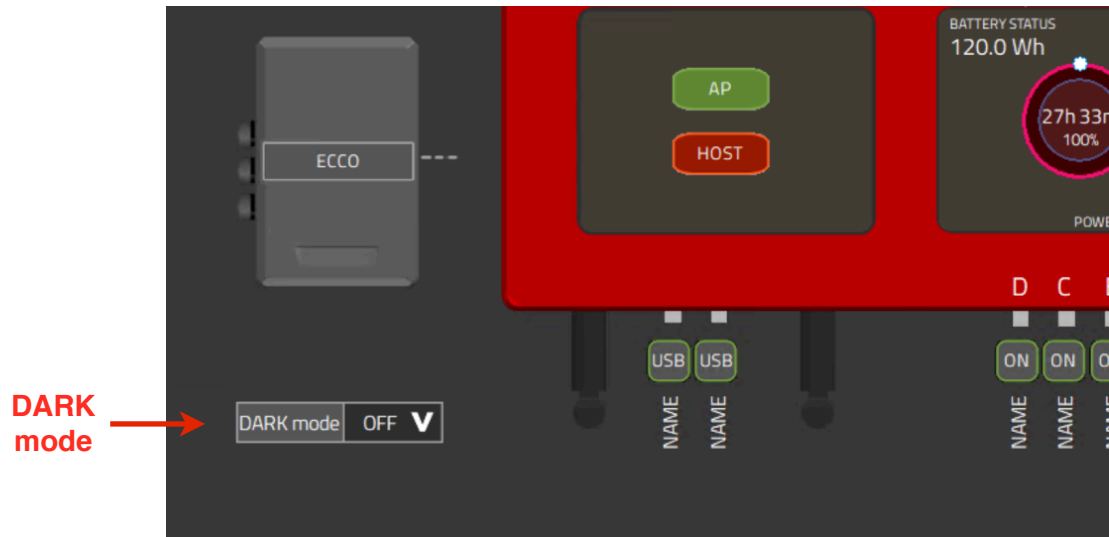

Image 52: The DARK mode switcher in EAGLE Manager interface

## Advanced use: EAGLE ASCOM drivers

The EAGLE includes ASCOM drivers in order to allow third party softwares to connect to EAGLE’s ports and sensors:

- **PLL Environmental Conditions ASCOM driver:** this allows third party softwares to access to the EAGLE EYE sensor data (only for EAGLE4), for example to save the sky darkness data in your astrophotography image (image 53). If you have also the optional ECCO2 environmental computerised controller, you can also see air temperature, humidity and pressure.

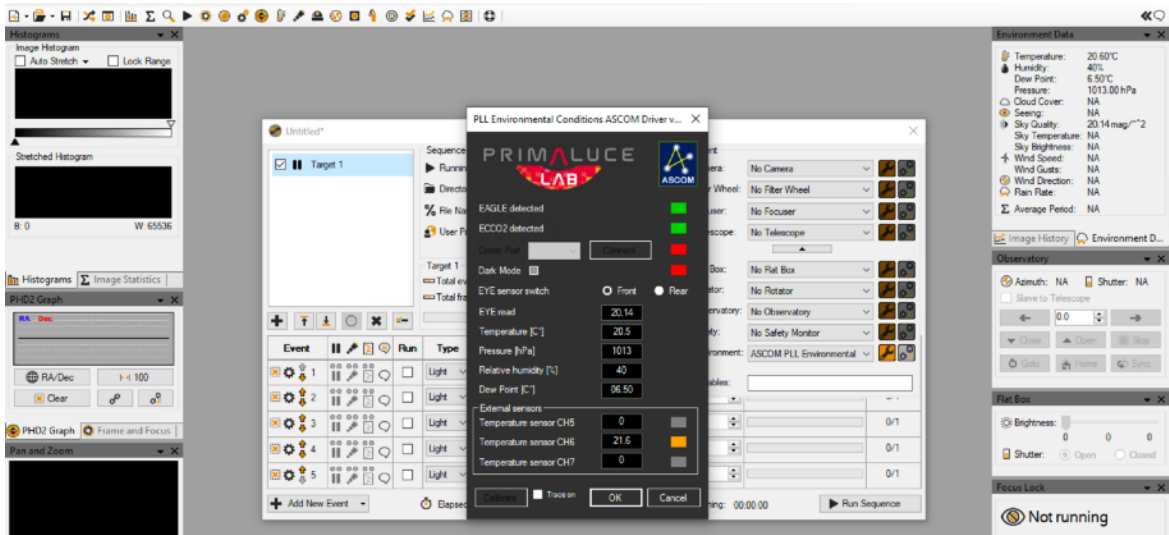

Image 53: Sequence Generator Pro connected to PLL Environmental Conditions ASCOM driver

- **EAGLE Switch ASCOM driver:** this allows third party softwares (that supports power switches control) to take control of the EAGLE’s power and USB 2.0 ports A, B, C and D in order to automate ports management (Image 54).

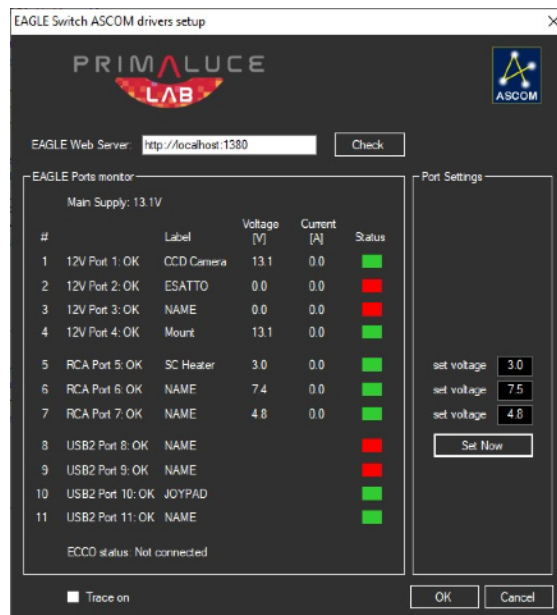

Image 54: EAGLE Switch ASCOM driver

EAGLE’s ASCOM drivers are already installed in your system. Updates can be found at <https://www.primalucelab.com/astronomy/downloads>. EAGLE's ASCOM drivers require at least ASCOM platform 6.4 that is already installed on your system.

## Advanced use: program connection and power to devices

In the ADVANCED SETTINGS window, you can determine how EAGLE Manager sets USB and power ports (except for the USB 3.0 ports that will always be active) when EAGLE is turned on or off. This way you can, for example, schedule to turn on or turn off your devices when you turn on or off EAGLE. The "Configuration after startup" allows you to set the status of ports when EAGLE turns on, the "Configuration before shutdown" field allows you to set the status of the ports when EAGLE turns off (Image 55).

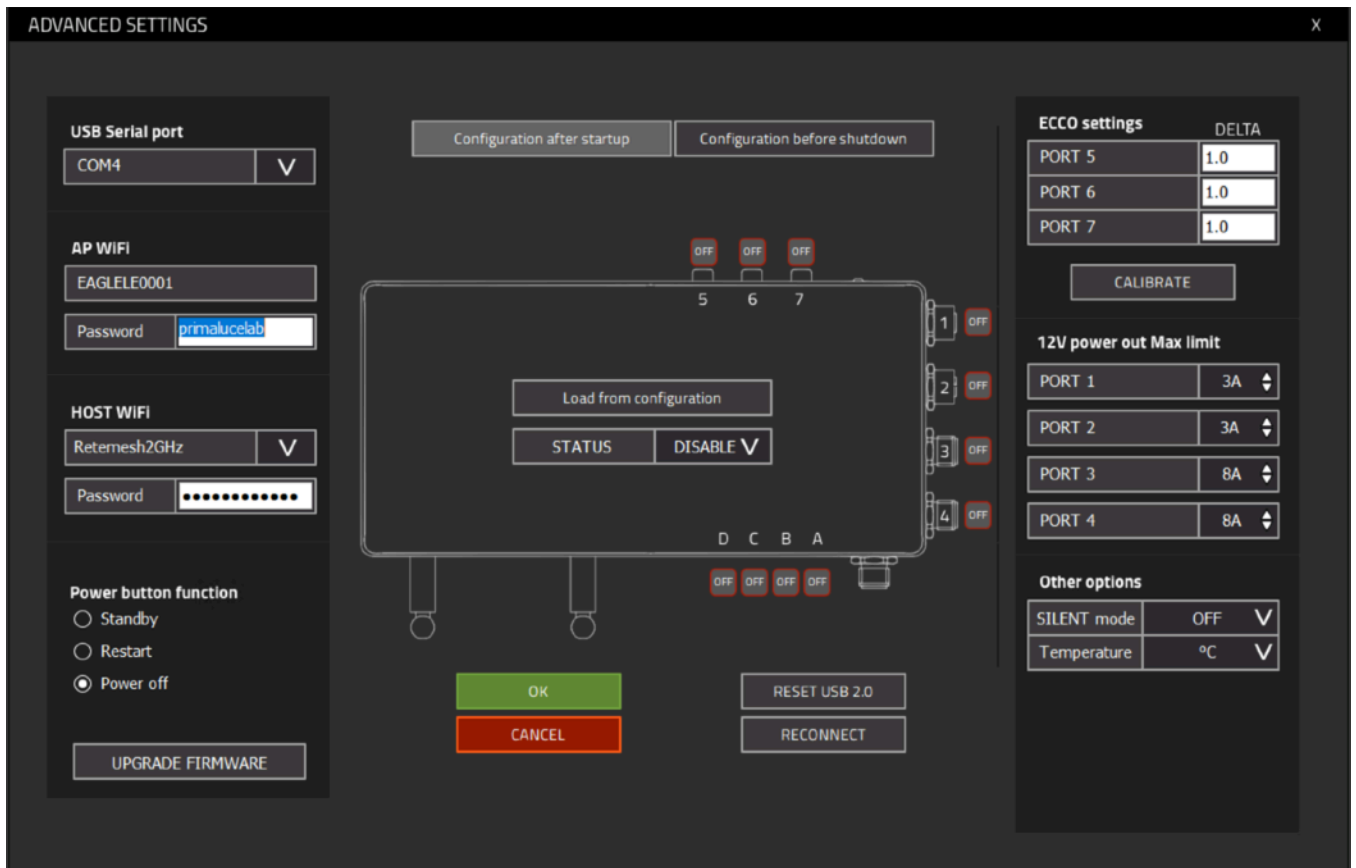

Image 55: ADVANCED SETTINGS window

To enable this feature, click on the "Configuration after startup" or "Configuration before shutdown" you want to set. Then click on the ports to set if you want them ON (green) or OFF (red) and select "Enable" close to STATUS. You can also press the "Load from configuration" button in order to recall the actual status of the ports as it is set in the EAGLE Manager main window. Click the OK button to confirm and the current configuration of EAGLE ports will be saved and applied each time you turn on/off the EAGLE.



## Advanced use: remotely turn on EAGLE with wired connection

EAGLE is designed to allow you, in a simple and fast way, to remotely control your telescope that is connected and powered by EAGLE. In this chapter we will see how to remotely switch on the EAGLE (and all the powered devices) setting up a direct wired connection via a computer network cable to the EAGLE.

### NOTE:

This feature is available only with a wired connection, not with WiFi.

This methods involve the use of a cabled connection, and it is typically used to remotely control an entire telescope installed at a fixed location (for example, on observatory of amateur astronomy association or in your back yard). **In this mode you can turn on remotely EAGLE and then power the devices.** If you want to remotely control the EAGLE in a different way than the one here described, please contact us and we will help you customize your system.

The simplest way of remote control is the wired one, with a direct connection from a single computer to EAGLE. For this use, you will need a cross-type Ethernet network cable to be connected to the EAGLE ethernet port and in the one of your control PC . Then:

- In EAGLE, select Start button  then click on Control Panel and select "Network and sharing center"
- Select "Change settings", double click on the Ethernet connection (image 38) and select "Details".
- A window with the details of the network connection will open
- Write down the value for the "Physical Address" (image 57).

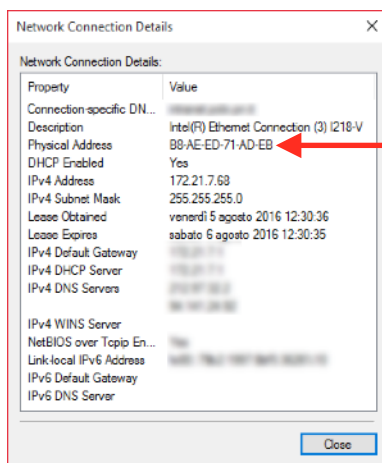

Image 57: Details window

Write down the value for the  
Physical Address

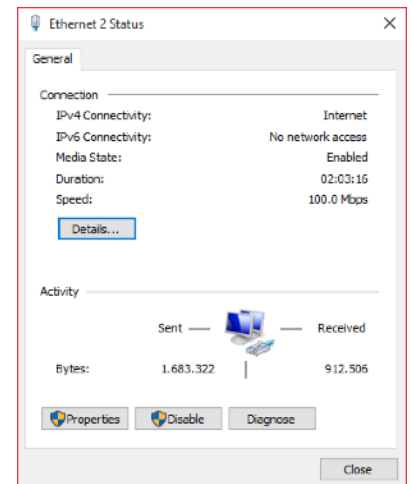

Image 56: Ethernet window

It is therefore necessary to set a static IP address for EAGLE. To do this, select the Start button and then click on Control Panel and select " Network and sharing center." Right Mouse click on "Ethernet" and select "Properties" (image 58).

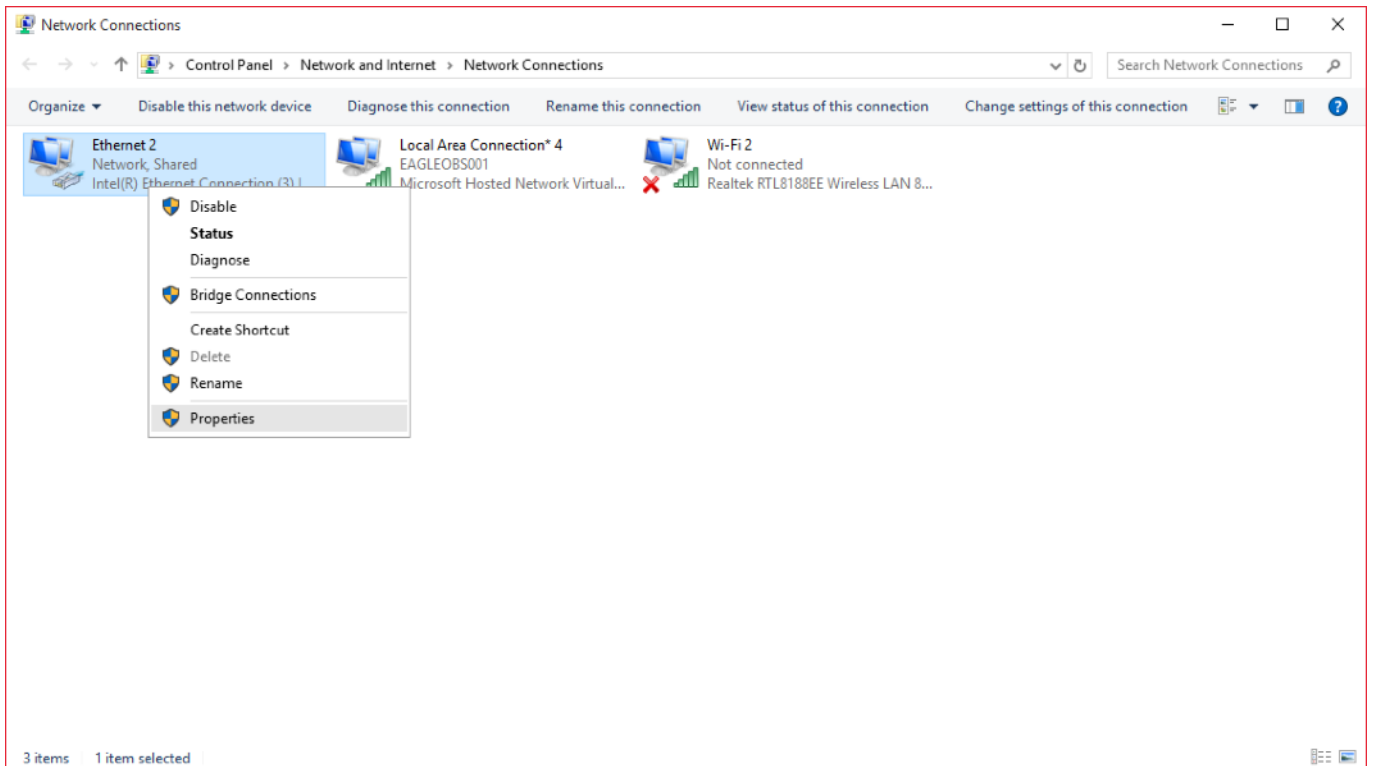

Image 58: Network connections window

In the window that opens, click on "Internet Protocol Version 4 " and press the "Properties" button. In the window that opens, select the "Use the following IP address" and write in the first two fields the following values :

IP address: 192.168.100.100  
Subnet mask: 255.255.255.0

Then click OK to confirm . Also the computer you want to use to control EAGLE must have a static IP then, in this computer, repeat the steps above but entering the following value :

IP address: 192.168.100.200  
Subnet mask: 255.255.255.0

(they are the same numbers, it only changes the last digit of the "IP address"). Then click OK to confirm (image 59).

In order to remotely turn on EAGLE, now you need a software that allows you to send it a message called "Wake On Lan". There are several free or pay-to-use solutions, in this example we will see how to do it using an Apple computer with OSX operating system.

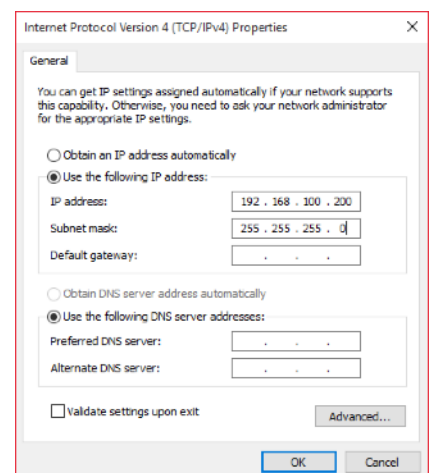

Image 59: IPv4 properties window of the computer used to remotely control EAGLE

Access to the App Store and search for the application "Wake On Lan". Install it and run it.

Then set:

- in the field Mac Address: the number that you previously wrote
- in the field IP Address: 192.168.100.255
- in the field Subnet mask: 255.255.255.0
- in the field Port: 9

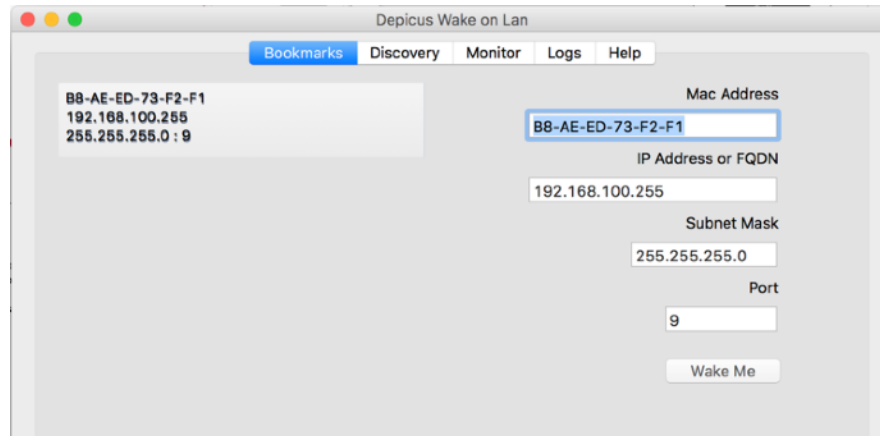
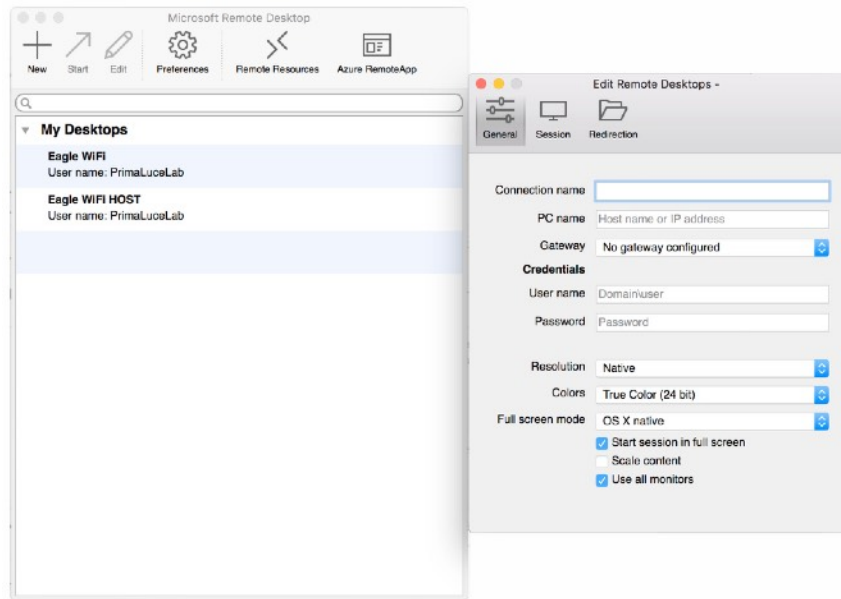

Image 60: Wake On Lan software window

By clicking the "Wake Me" button (image 60), your computer will send to EAGLE the command that turn it on remotely (then it replaces the physical press of the ON/OFF button).

After you remotely switch on EAGLE with a network cable connection, you will need to set up a new connection to the Microsoft Remote Desktop software on your computer to control it. In this example we will see how to set it from a Mac computer, but it is also valid for Windows computers. From the computer where you want to control EAGLE from, start the Remote Desktop software, then click the "New" button to set up a new connection. Then set:

- In "Connection name" field enter a name for your connection (for example "EAGLE Wired" to better highlight wired connection than the wireless one)
- In "PC name" field, enter the static IP of the EAGLE that is **192.168.100.100**
- In "Username" field enter **PrimaLuceLab**
- In "Password" field enter Windows access password you find in the EAGLE quick guide



*Immagine 61: set the Remote Desktop for wired connection*

Create the new connection, click on the name of the newly created connection (in our example "EAGLE Wired") to activate the remote connection (Image 62).

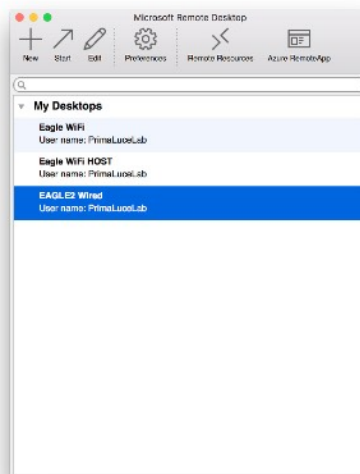
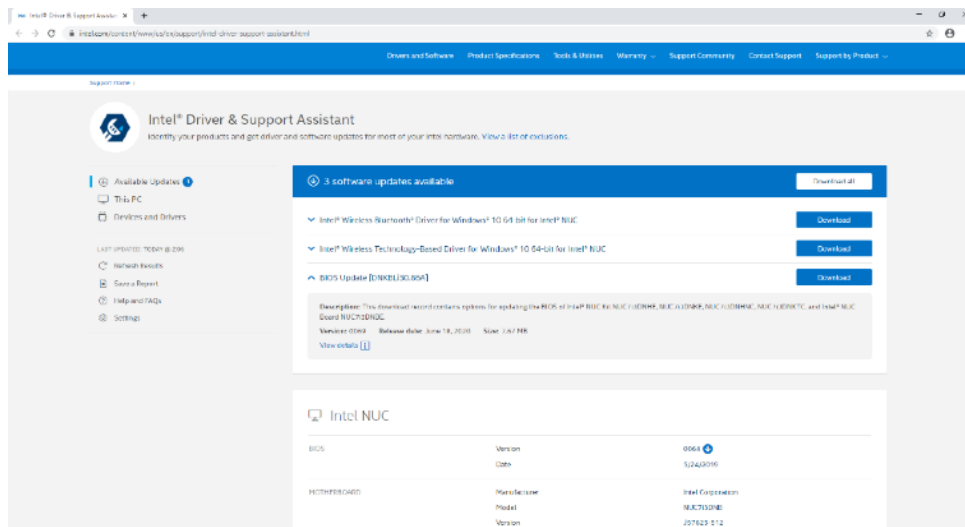

*Image 62: start wired remote connection*

**Tip: if, using EAGLE Manager, and you are no longer able to control power out ports or USB ports of the EAGLE, go to ADVANCED SETTINGS and click RECONNECT button.**

## Advanced use: configure EAGLE to automatically start when power is restored

The EAGLE may be set to automatically turn on and start Windows when power is restored. This is a very useful feature in remote observatories: in this case the EAGLE would automatically restart after a power outage. Another useful application is the possibility to turn it on remotely without having to press the power on button. If you connect EAGLE's power unit to a power socket with remote control (there are many in the market), you will be able to remotely start power, the EAGLE will automatically start and you will be able to remotely access Windows with EAGLE Manager interface, this way starting all the other devices that are powered through the EAGLE. Let's see how to configure the EAGLE to automatically start when Power is restored. In order to start the configuration, the EAGLE has to be connected to the internet (for example by connecting it to your router with an ethernet cable), it has to be connected to an HDMI monitor and with a USB keyboard and mouse connected to the USB ports of the EAGLE (this allows you to use it as a standard computer). Turn on your EAGLE and open the Internet browser (for example Chrome). In Google, please search for "Intel Driver & Support Assistant", click on the first result on the page and download the installer. Start the installer and press LAUNCH. This will open a new browser page that will show if you have any updates available to install. If you have a "BIOS Update" available, click on the "Download" button to the right of the available update to download it, then press the "Install" button to apply the update. A new window will appear, press "Restart and install bios". This will restart Windows, please wait for the process to complete. Very important: **DO NOT REMOVE POWER FROM YOUR EAGLE DURING BIOS UPDATE.**



After the BIOS installation, Windows will reboot. Please shut down your EAGLE by pressing "Start" and then "Shut down". After the EAGLE is turned off, please press the Power On button of the EAGLE and, as soon as you see the PrimaLuceLab logo on the screen, please press the F2 button in your keyboard to enter in the motherboard BIOS.

Here press the ADVANCED button and then press on the "Power" tab. In the window that opens, click on "Secondary power settings" and, under "After power failure", change it from "Stay off" to "Power on".

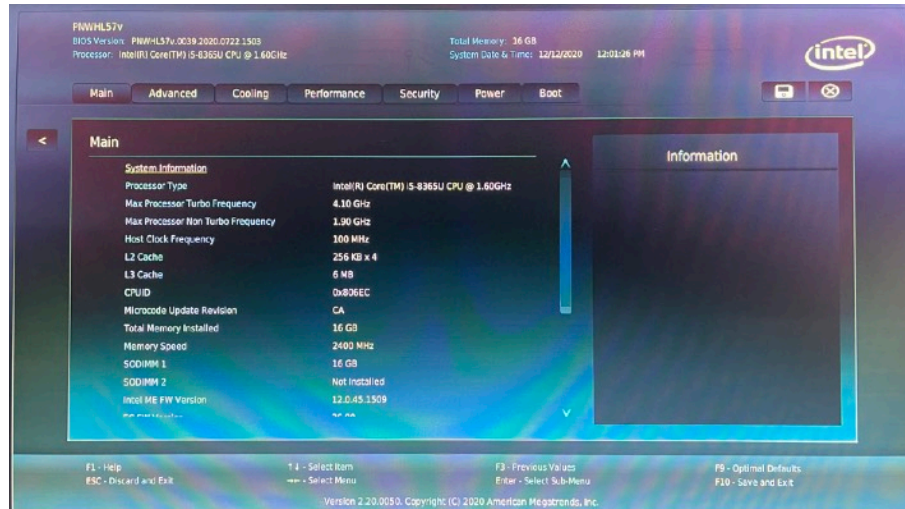

Now press F10 on the keyboard to save, then press YES to confirm. This will reboot your EAGLE. Now, every time you connect EAGLE to the power, it will automatically start without having to press the power on button of the EAGLE. In order to come back to the previous setting, please select "Stay Off" in the "After power failure" option.

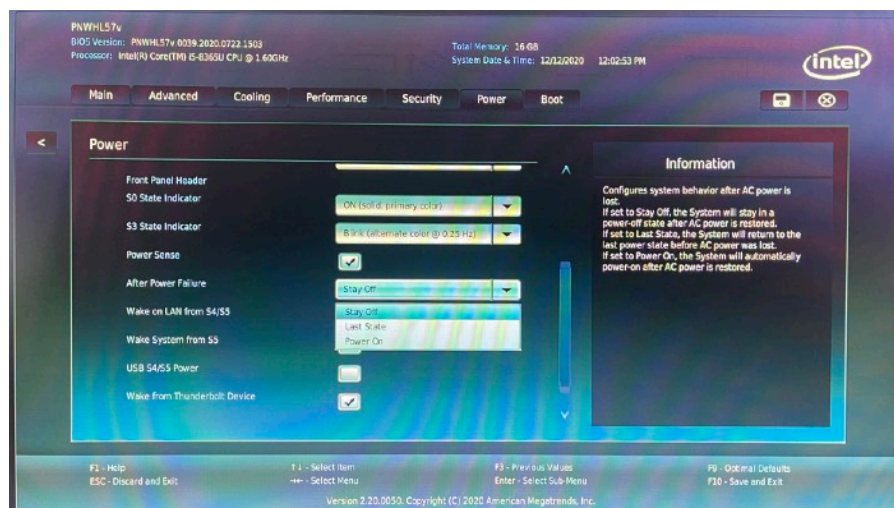

## Controlling the telescope remotely with Cartes du Ciel

Sky Charts is a free planetarium software for Windows that shows all the sky objects and lets you control the telescope. This way to you remotely control using the EAGLE the telescope position. In order to do this you need to have:

- 1) a computerized mount
- 2) installed the ASCOM driver of the computerized mount into the EAGLE (the ASCOM platform is pre-installed in the EAGLE)

Please follow this easy steps in order to remotely control the mount using Cartes du Ciel planetarium software:

- 1) Start Cartes du Ciel, you will see this window

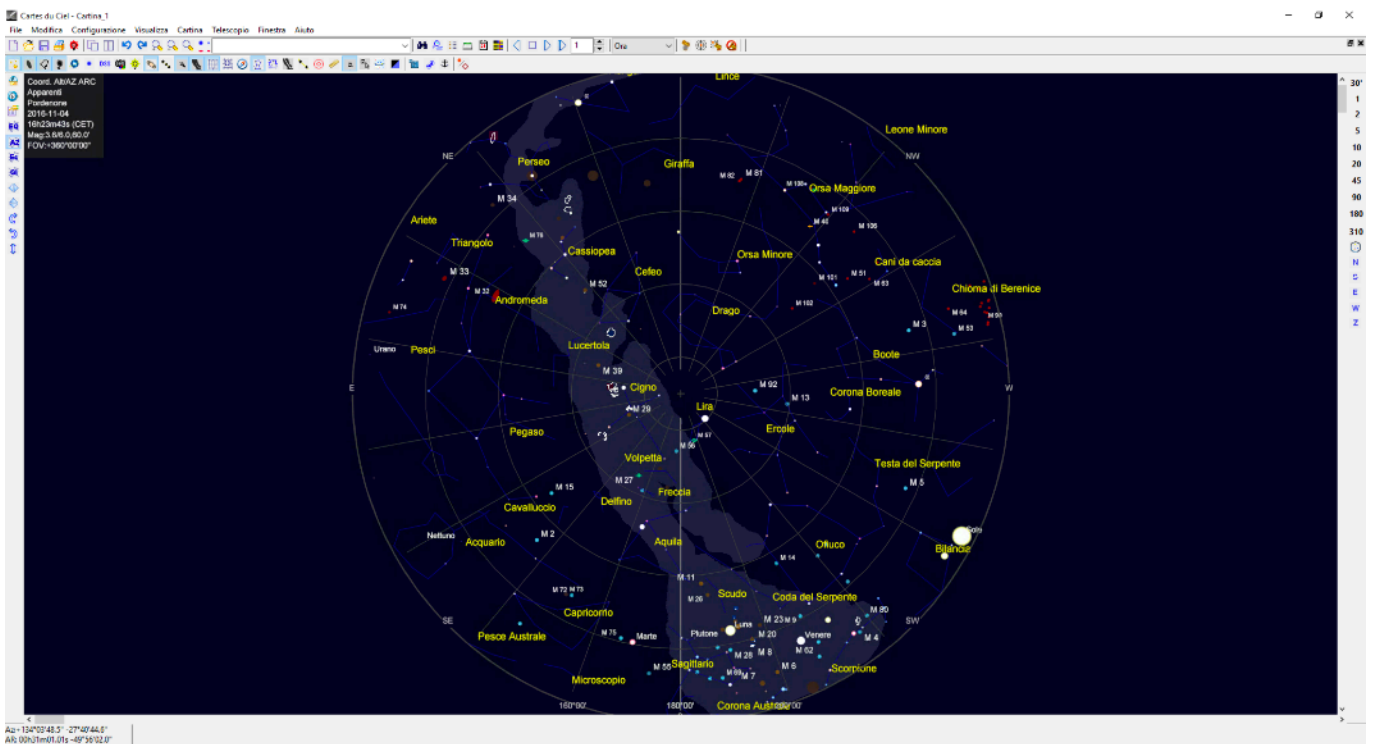

- 2) Select "Telescope" and then "Telescope Settings", this will open a new window, please select that "ASCOM" option is selected under "Telescope" tab. Then click OK to close the window.

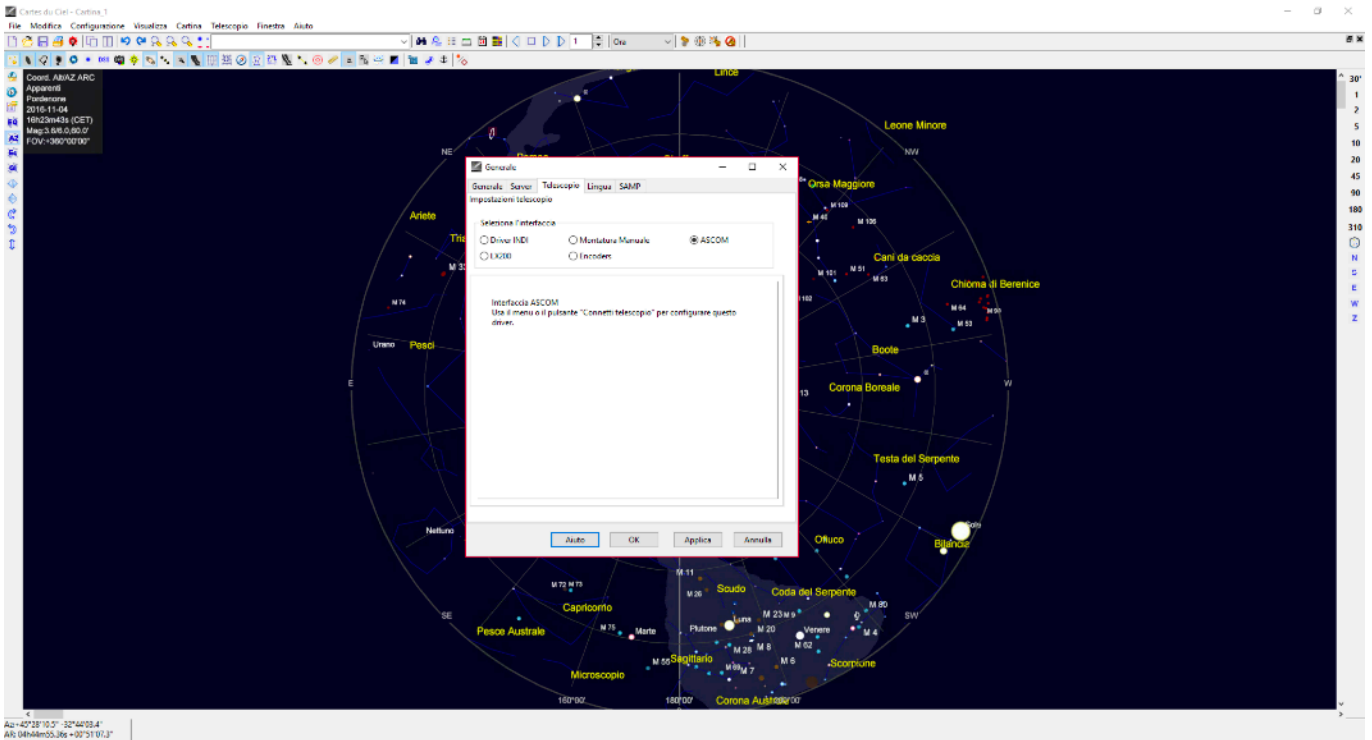

3) Select “Telescope” then “Control panel”. This will open a new window “ASCOM interface” . Click on “Select” and this will open a new window “ASCOM Telescope Chooser”. Now, based on the way you connect the mount to the EAGLE, here you need to select the ASCOM driver.

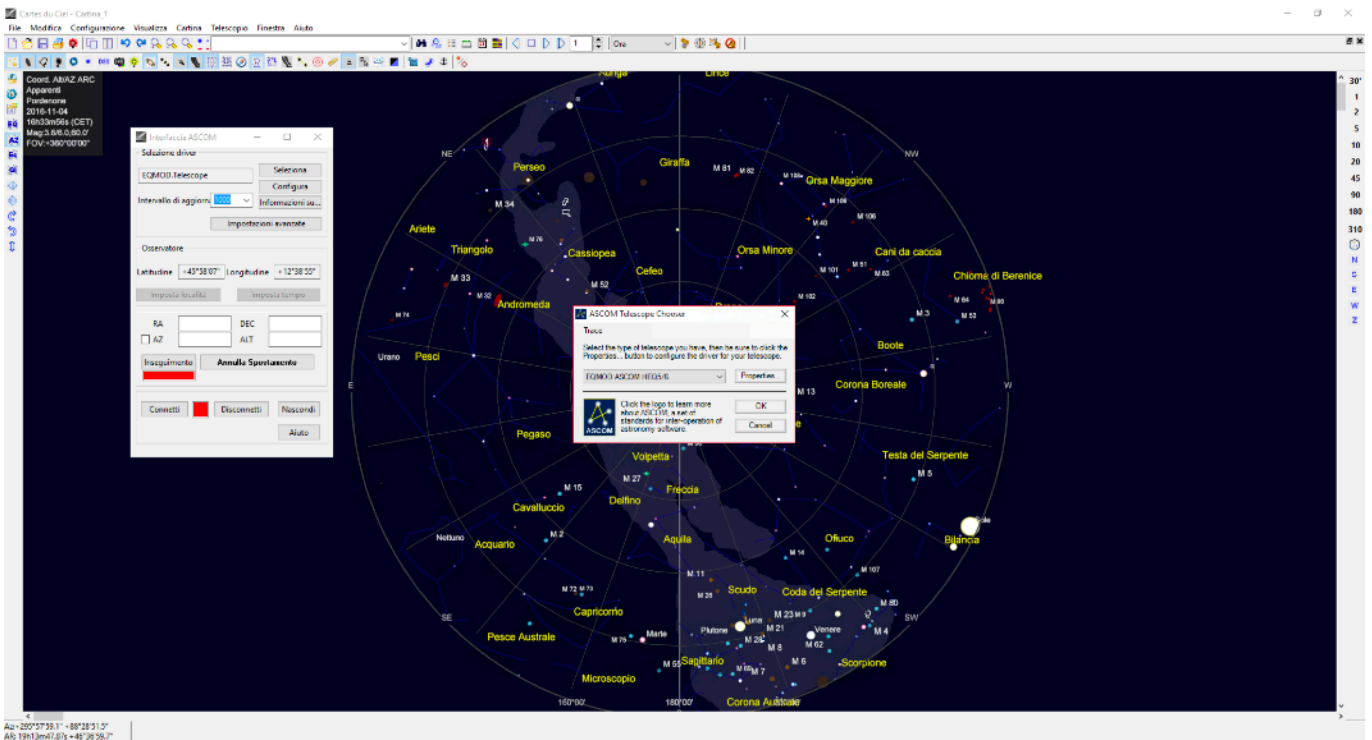



For example, if you use a SkyWatcher mount, you may use the “EQMOD USB interface for SkyWatcher mounts” that directly connects the mount electronics to the EAGLE using a USB port.

EQMOD cable directly connects the HandPad port of the SkyWatcher mounts to the USB port of the EAGLE

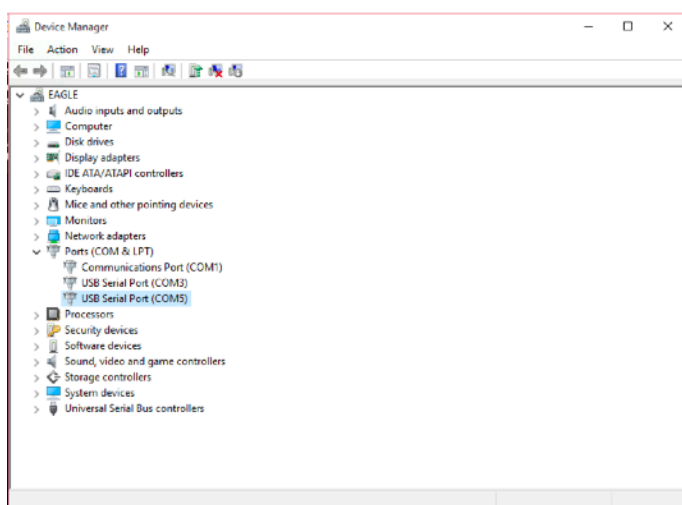

The “EQMOD USB interface for SkyWatcher mounts” comes with an ASCOM driver that you need to install BEFORE starting Cartes du Ciel planetarium software. The EQMOD creates a virtual COM port you need to know the number. In order to do that, go to Windows Control Panel, then select “System” and then “Device Manager”. In the window that opens, double click on “Ports (COM & LPT)” and look at the “USB Serial Port” number that opens (Please note: in Eagle Observatory the COM1 and COM3 are used for other applications”). In our example, the EQMOD created a COM5 port.

- 4) In the “ASCOM Telescope Chooser” window select “Proprieties” and the “ASCOM configuration” window will open. Set the right number port in “Port” field and then press OK to close the window.

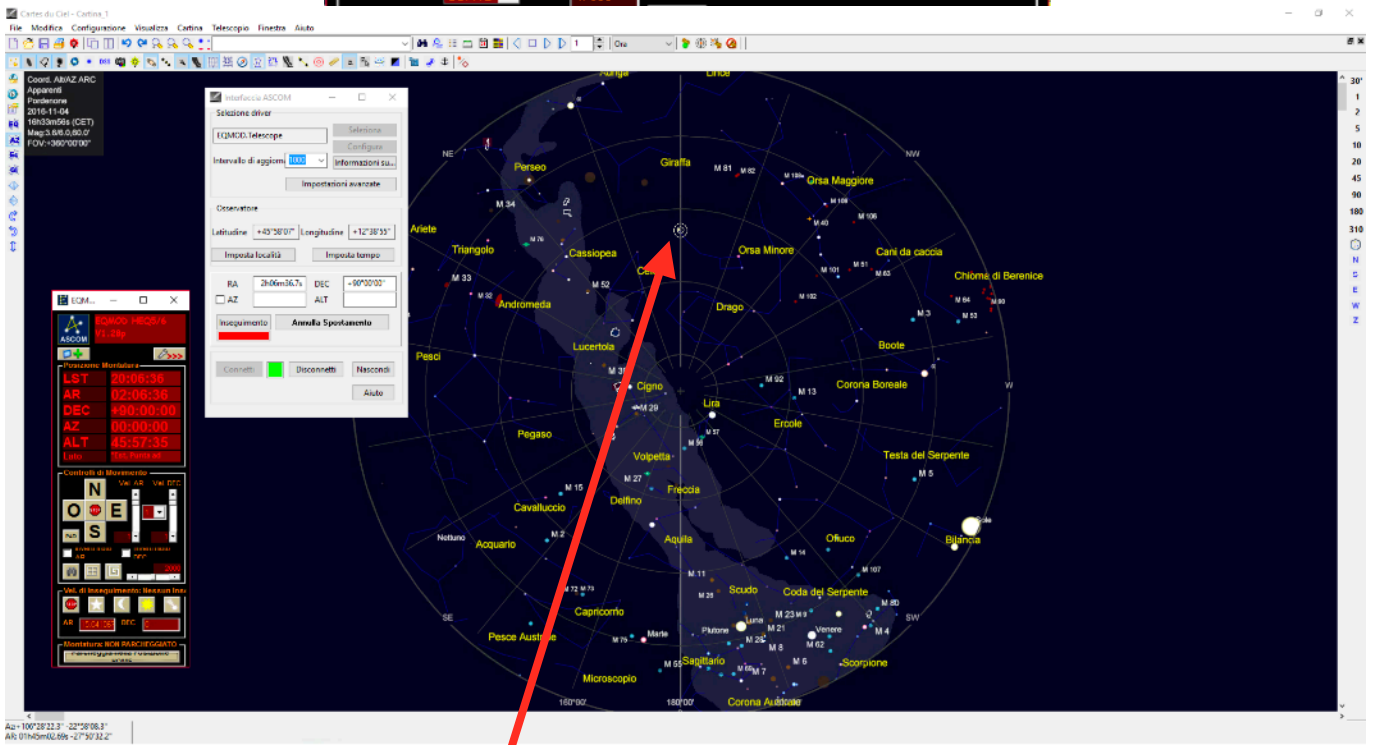
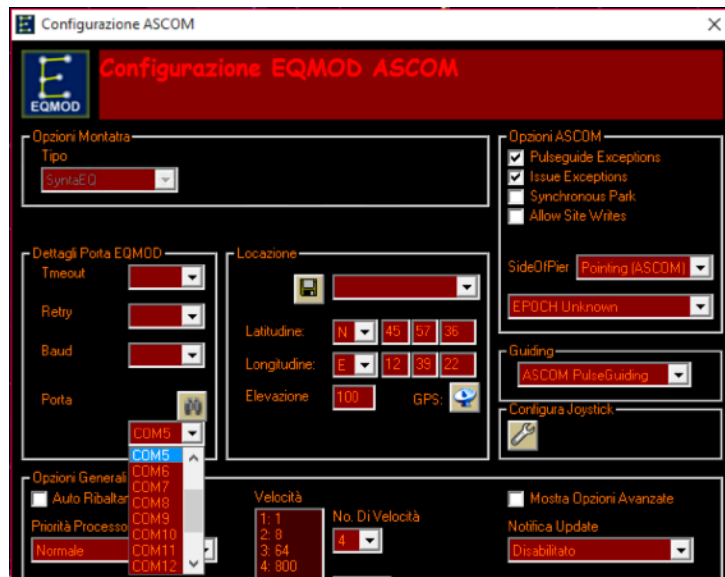

Actual telescope position

- 5) Press OK in the “ASCOM Telescope Chooser” window and then press the “Connect” button in the “ASCOM interface” window. The red button will become green and the EQMOD window will appear. Now you’re connected to the mount and you can remotely control it.

6) A circle indicator indicates the telescope position, in this example it's in the North Polar star. In order to move the telescope

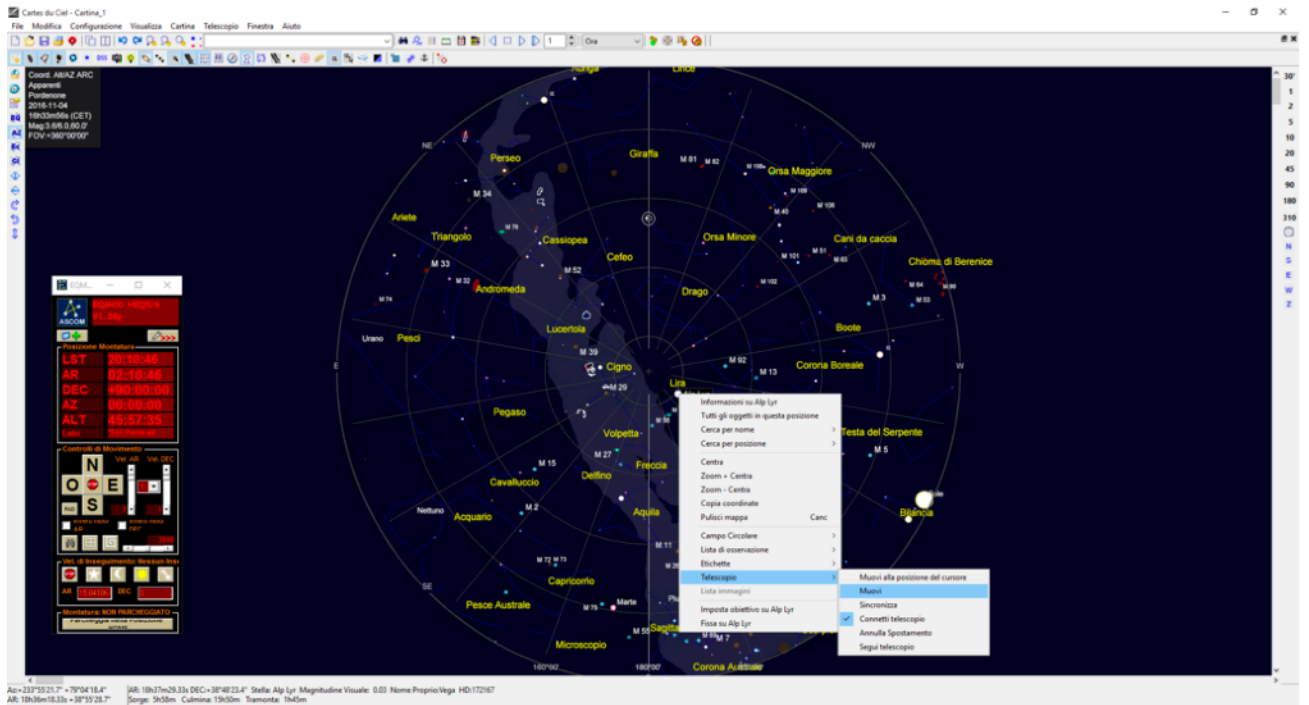

to a desired object you can see in the planetarium window, you can select the object, make a right mouse click, select “Telescopio” and then “Slew”. The mount will move to the selected object.

7) If, after automatic pointing of the mount, you see that the object is not perfect centered, you can easily align and synchronize the telescope position. In order to do that, after the telescope is moved to the required position, select the object then make a right mouse click, select “Zoom + Center”.

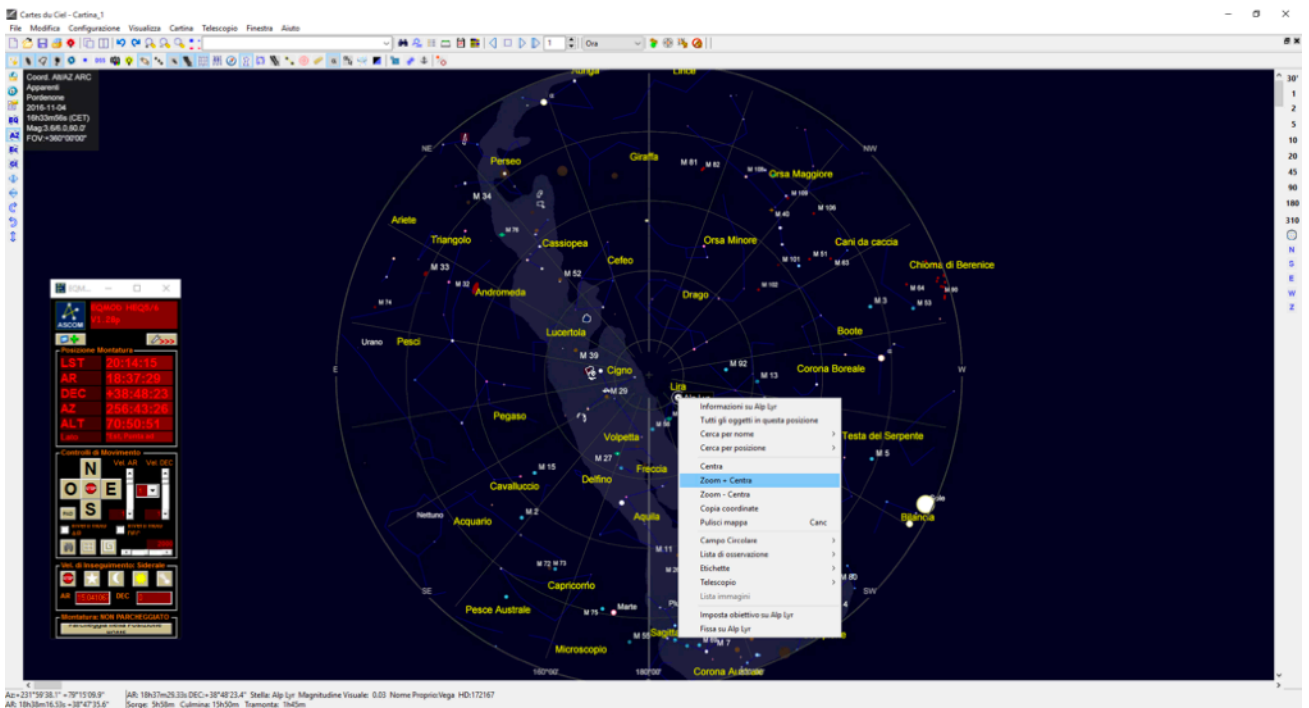

- 8) You can increase the magnification of the sky chart using the Zoom buttons. Then select one of the available speeds in the speed selector (3 or 4 are ok for object centering) and center the object in the telescope field of view (in your eyepiece or in the camera)

Zoom buttons

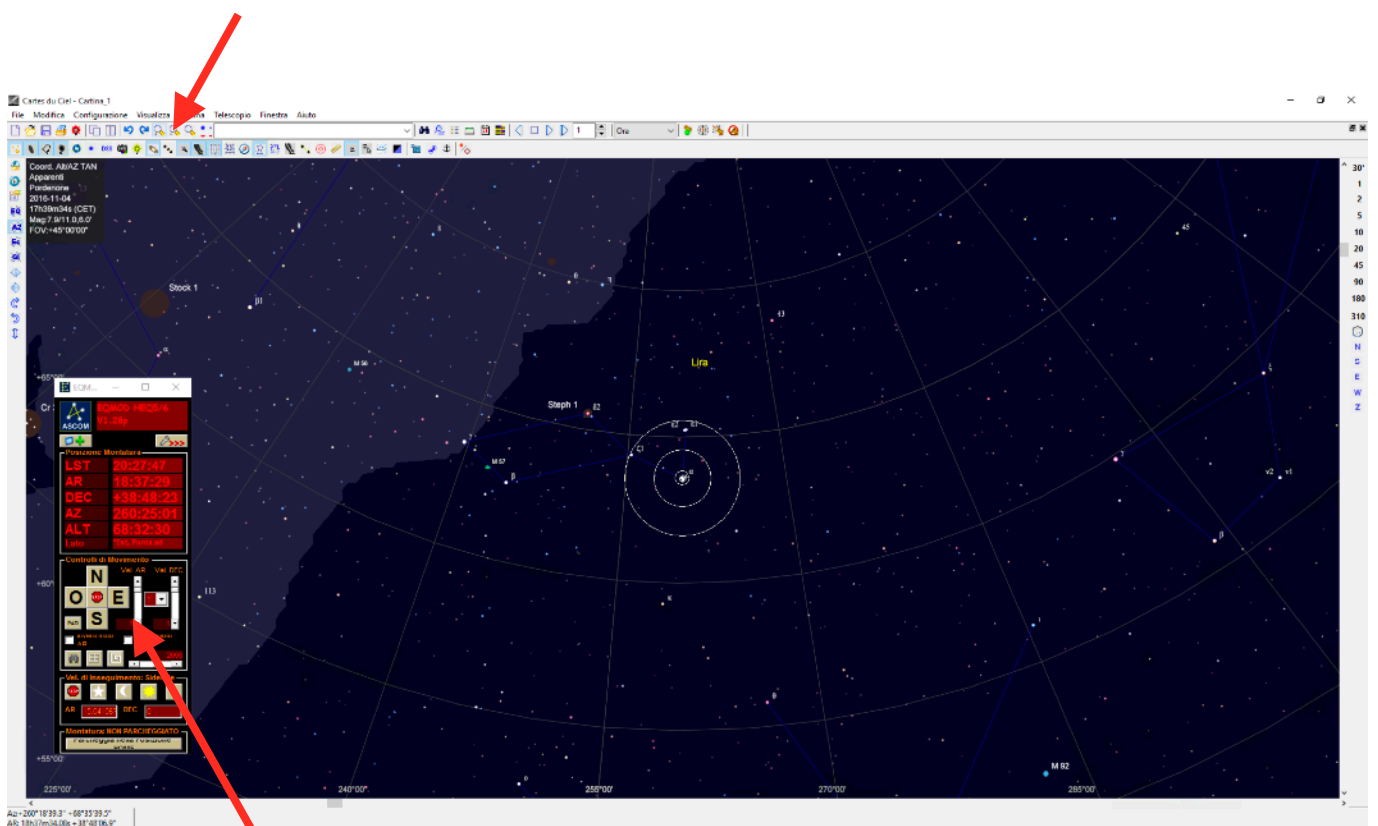

Speed selector and direction buttons

- 9) When done, select the object you're pointed in (in this example Vega star), make a right mouse click, select "Telescope" and then "Synchronize". A new window will appear asking if the telescope is pointed at the object. Press YES to confirm.

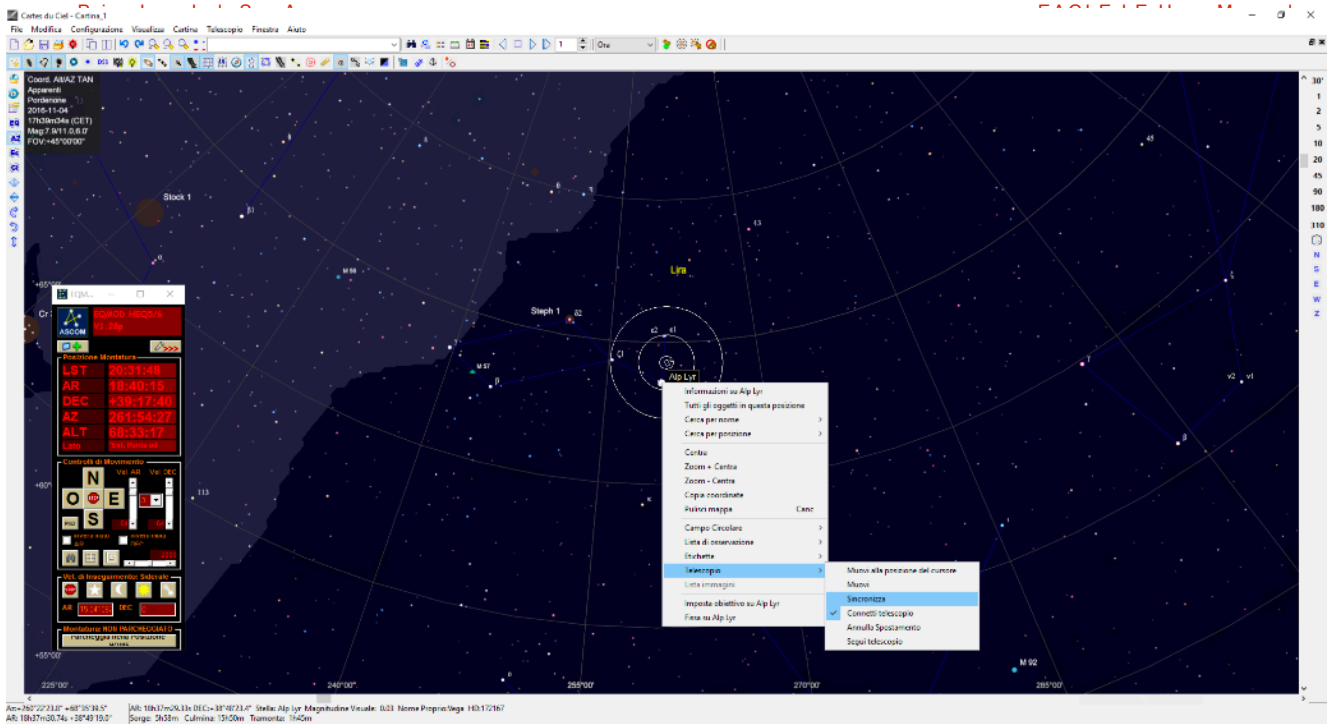

10) The telescope will be synchronized and the sky chart position will be set to the object.

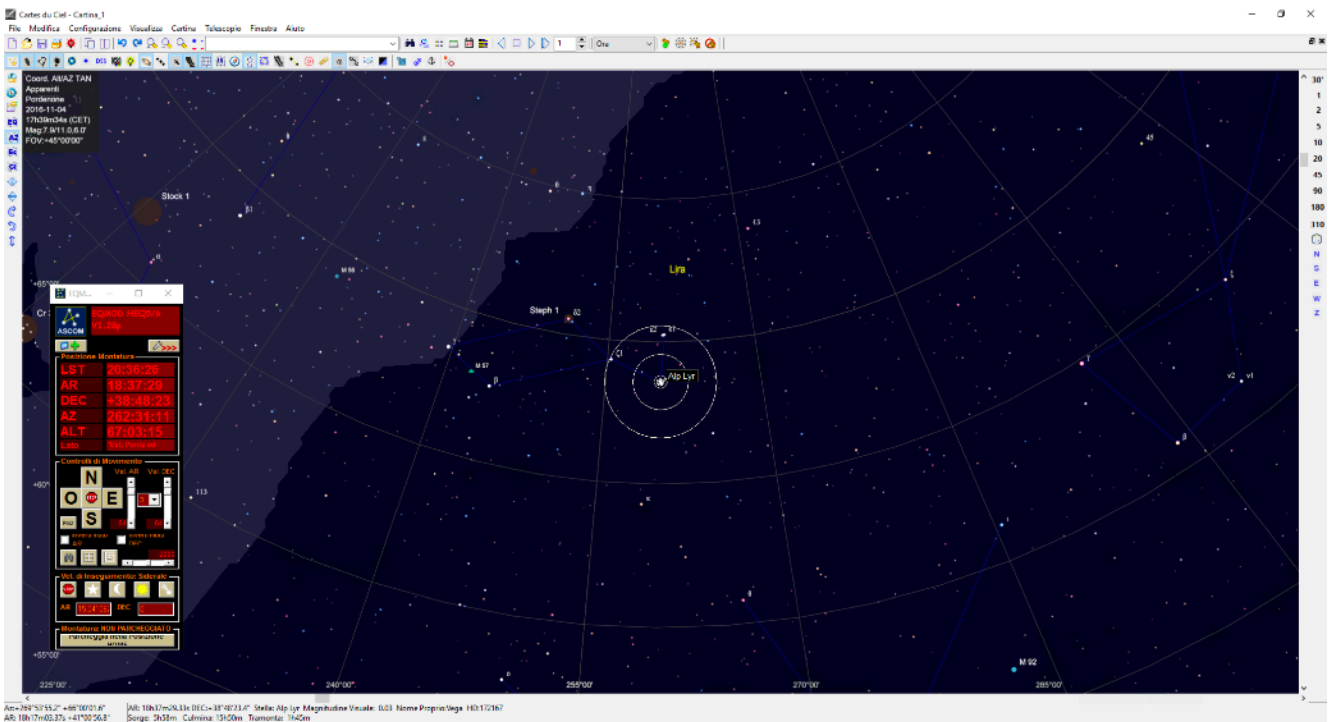

11) When you want to disconnect the planetarium software from the mount, select “Telescope” then “Control panel” and then “Disconnect”. You will be able to close the Cartes du Ciel software.

## Autoguiding with PHD2 Guiding

PHD2 Guiding is a free software among the most used for autoguiding since it's very easy to use. In this tutorial we will explain how to set up this software (that is pre loaded into the EAGLE) using a QHY5L-II camera but the same steps can also be made using other autoguiding cameras.

The autoguide is a technique that involves a guider camera (usually we use cameras equipped with highly sensitive sensors to find more easily the guide stars). Connected to a secondary telescope in parallel to the main one, or to an off-axis guider, the autoguide camera generates the guide star image that is analyzed by a special software (the autoguide software) that automatically sends tracking correction signals to the mount: everything is done to obtain, even with long exposures, perfect images with pinpoint stars.

Follow these steps to get started easily in autoguiding:

1) Start PHD2 Guiding, the following window will open.

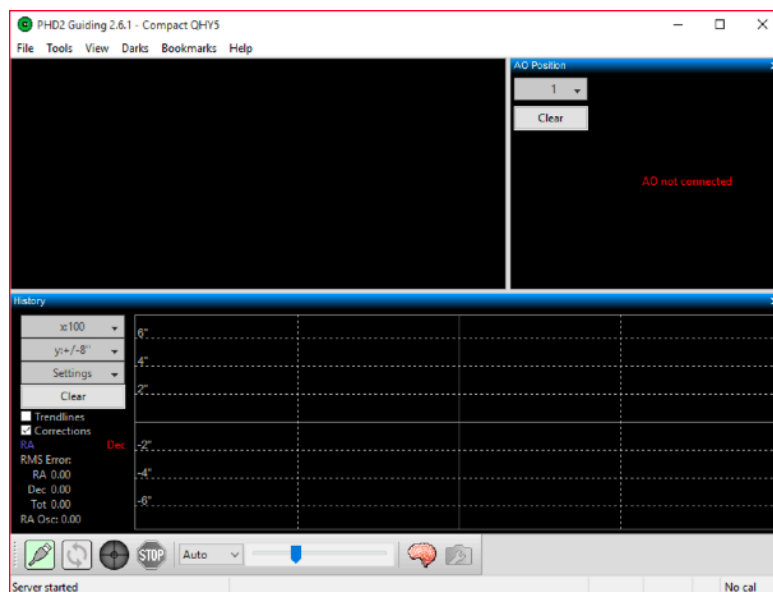

2) Click the first button on the bottom left, it will open the window "Connect Equipment". Select your guide camera in "Camera" option. We used a QHY5L-II camera which is equipped with ASCOM driver so we selected "CMOS QHY5LII Camera". The first time you do this, when you click "Connect" a new window will open. Press OK to proceed.

3) In the “Connect Equipment” window verify that the “Mount” option is “On-camera”. This option is used when the camera integrates an ST4 autoguide port. Press “Connect” and then press “Close”. This will close the “Connect Equipment” window.

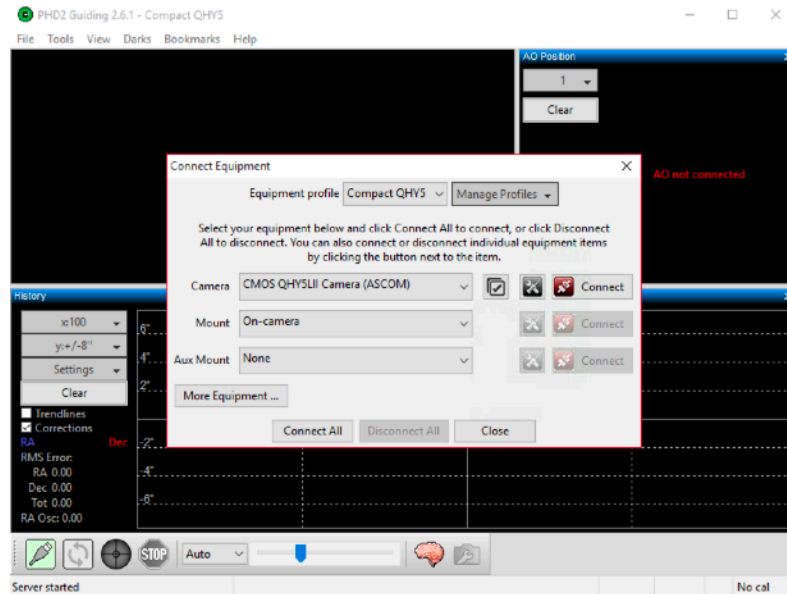

4) Now select a proper exposition time for the guide camera (usually 1 or 2 seconds) and press the “Looping” button (the one with 2 green arrows). This will start exposures of the guide camera and you will see the image in the preview window.

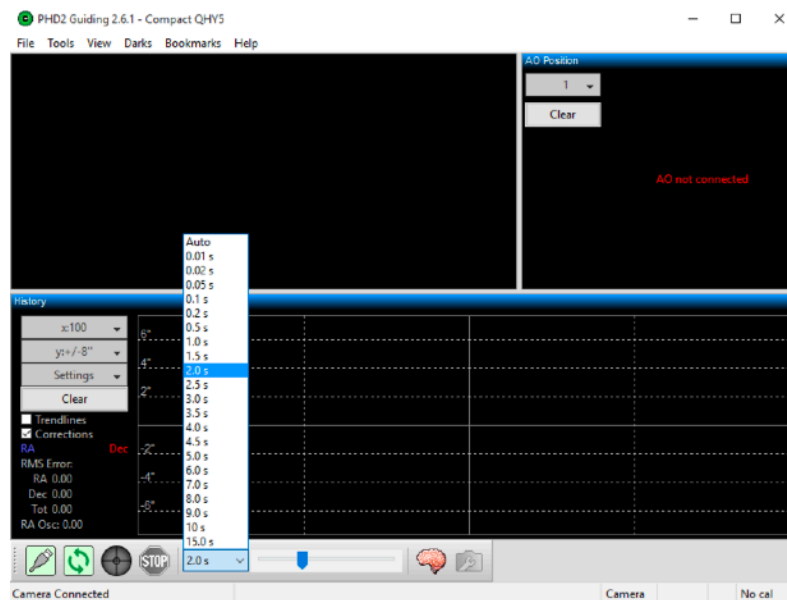

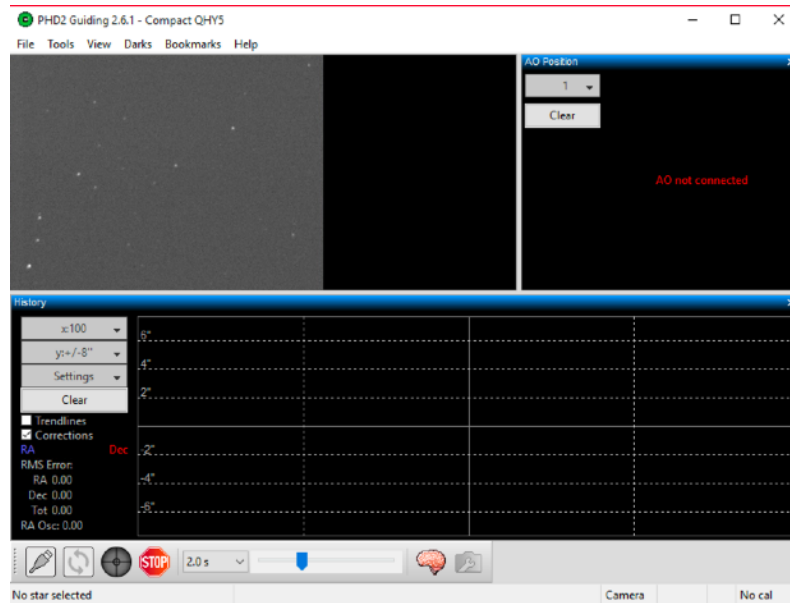

PHD2 Guiding will perform a loop images that will be displayed on the screen. Do not worry if, as in the image below, you notice a lot of background noise: in fact PHD Guiding automatically compresses the image histogram to help better visualize the guide stars and this makes especially the sky background very noisy (but it has no impact on guide accuracy). Probably your image will be out of focus so move the guide telescope focuser until you see the point stars on the screen. If you can not find the guide star you can adjust (increasing it) the shutter speed using the command in the bottom center. Tip: Never use shutter speeds that are too short, usually 1 to 2 seconds are fine.

5) Now, even if the software does not strictly require it, it is advisable to match the X and Y camera axes (columns and rows of the sensor) with the axes of movement of the mount: in practice it is better to see on the screen that, if for example, you slightly move the mount in RA or DEC, the reference star moves horizontally or vertically, but not diagonally. In this way, every time PHD Guiding detects a tracking error, it send a correction to the mount only in one axis and not both (thus reducing the guiding error). Rotate the guide camera until slightly moving the telescope in RA or DEC, you see that the stars are moving perfectly horizontal or vertical.

6) Now press the "Stop" button and click with the mouse on a star not too bright on the screen. The star will be highlighted by a square with green border.



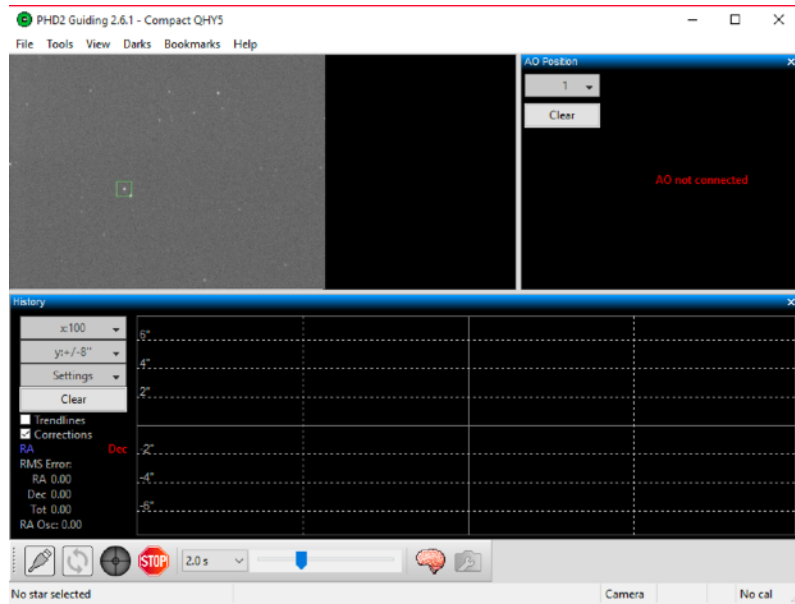

7) Then press the third button on the left (the one with the green icon): PHD2 Guiding will automatically start the calibration process that allows the software to "understand" which direction to move the guide star when a shift in the four mount movements (+ AR, AR, DEC +, DEC).

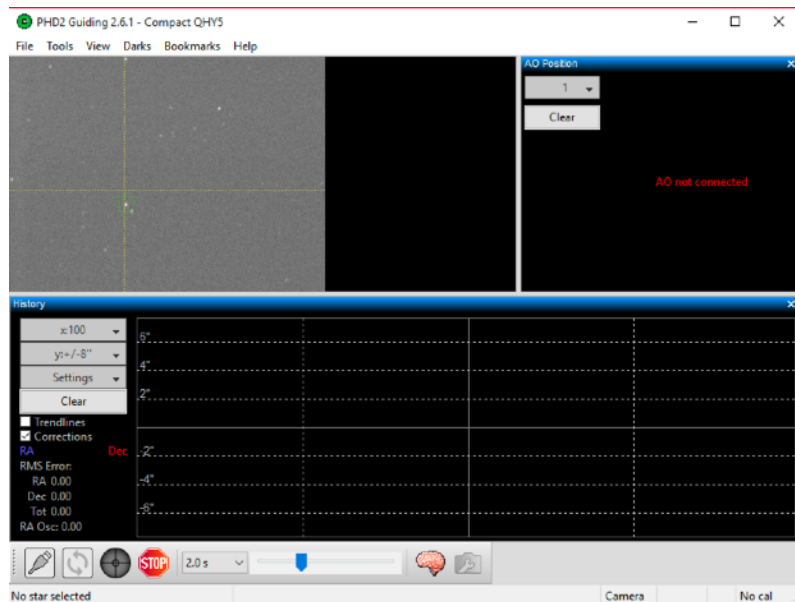

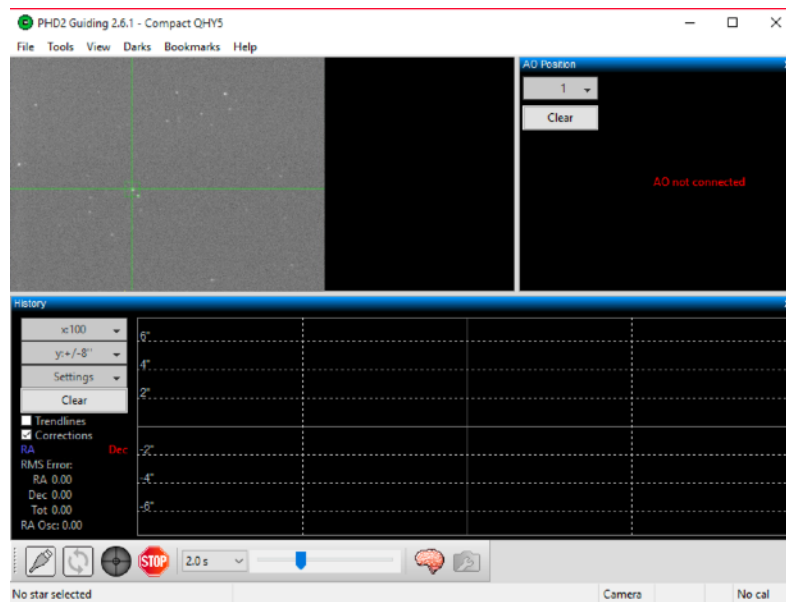

8) After the calibration, PHD2 Guiding will indicate the starting position of the guide star with two green lines (one horizontal and one vertical) and it will begin automatically guiding.

9) To check for guide quality, you can see the graph in the lower part of the PHD2 Guiding window.

This guide allows you to easily start guiding but PHD2 Guiding also has many advanced options to adjust and further improve performance. So if you still need help with getting pinpoint stars or improving your guiding, we invite you to read the PHD Guiding user manual for additional information.

## Drift Alignment using PHD Guiding

*In order to record the best astrophotography pictures it's important to record pictures with exposition times as long as possible. In order to do that the equatorial mount's polar alignment is fundamental. Here you find a great way to precisely polar align your mount using PHD2Guiding pre-loaded into the Eagle. Note: this guide is from Open PHD Guiding. All rights reserved.*

The drift align tool in PHD2 can be used to quickly obtain a precise polar alignment of your equatorial mount. The process takes a little bit of practice, but after doing it a few times, you should be able to obtain an accurate polar alignment in minutes.

### Preparation

- Make sure your mount is reasonably level.
- Make sure your scope is balanced and ready for guiding.
- Try to get your mount's polar axis roughly aligned by using your mount's polar alignment scope if it has one. Otherwise, make sure the mount's polar axis is pointing towards the pole, and the altitude setting corresponds to your local latitude.
- Make sure you can see your computer screen when you are standing at the mount.
- Start PHD2 and connect your equipment.
- You should be using an up-to-date version of PHD2, preferably version 2.3.11 or newer.
- These instructions assume you have an ASCOM connection to your mount so PHD2 knows where your scope is pointing. You can still drift align without an ASCOM connection, see Note about ASCOM.
- Calibrate on any convenient guide star, preferably at a low declination.
- Make sure your PHD2 settings have the correct values for your guide scope focal length and your guide camera pixel size. (Brain => Global tab for focal length, Camera tab for pixel size)
- Now you are ready for drift aligning.

## Azimuth Alignment

Open the Drift Align Tool:

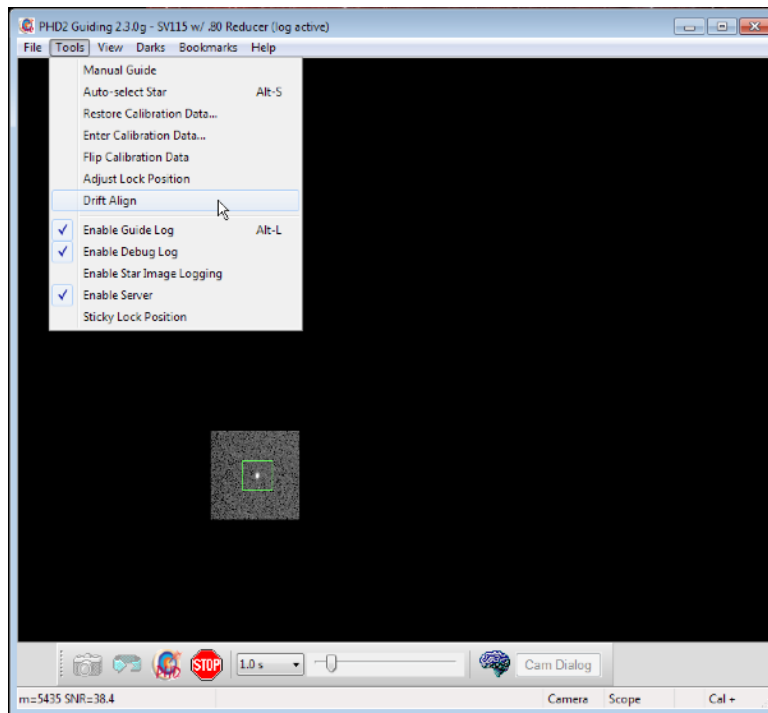

You will see a window like this:

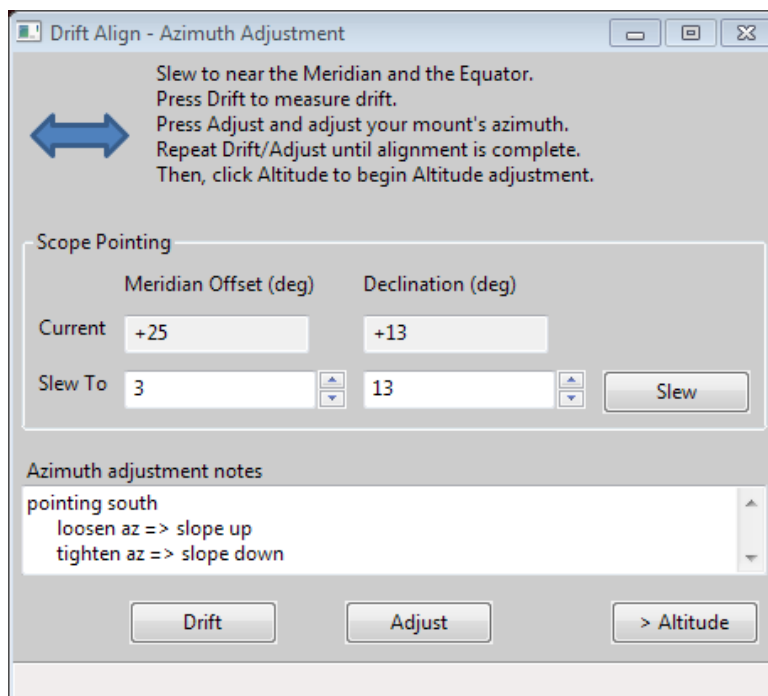

Position your scope for the Azimuth axis adjustment. Point near the Meridian and the celestial equator. You can either click the Slew button, or move the mount manually. Your scope should now be pointing something like this



And the Drift Align window will look like this

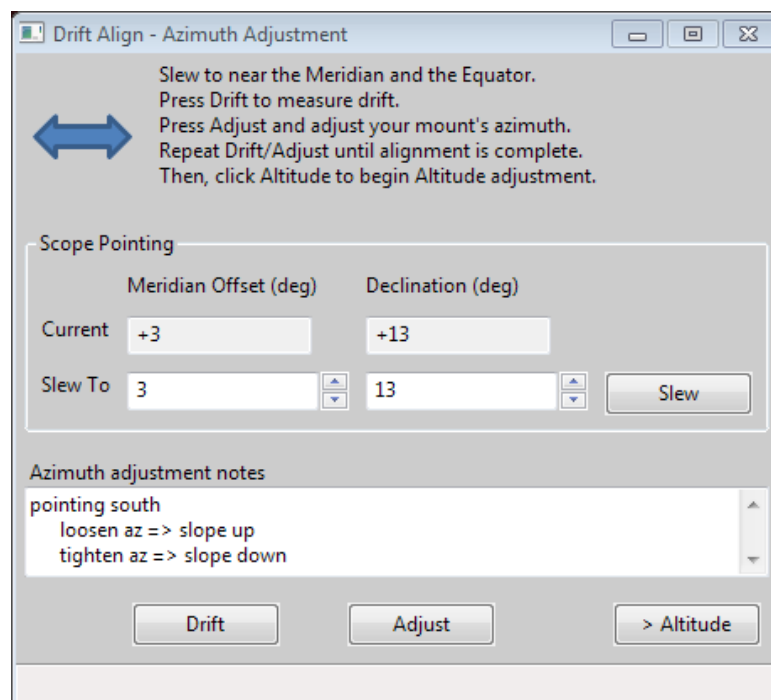

Notice we are only a few degrees off the meridian ("Meridian offset"), and close to the equator (small value of Declination.). You are going to alternate between measuring the error (Drift), and adjusting the mount (Adjust). The rate of declination drift tells us the amount of alignment error. Each adjustment will reduce the error, and you repeat the process as many times as you need to get the error close to zero. Click Drift to start measuring the declination drift. PHD2 will select a guide star and start guiding. After a few moments you should see something like this:

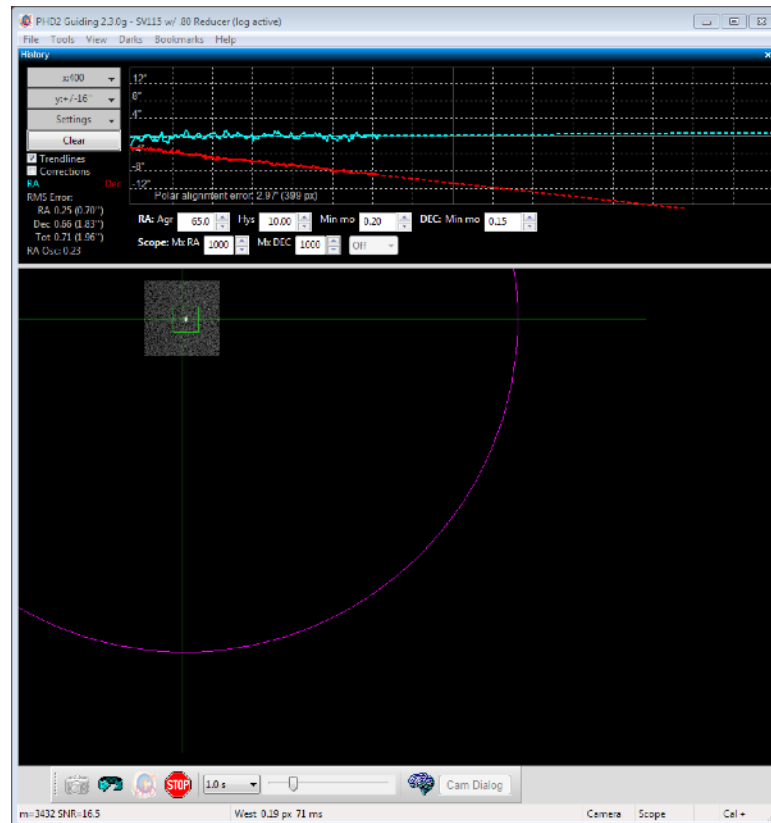

Pay particular attention to the Declination trend line (Red). At first the Dec trend line will be jumping up and down, but soon the noise should "average out" and the slope of the line will become somewhat stable. When that happens you are ready to adjust the mount's Azimuth. Our goal is to make the Dec trend line "flat" -- neither trending up nor down over time. By adjusting the mount's azimuth, you will change the slope of the Dec trend line.

If this is your first time adjusting Azimuth, you will not know which way to go--East or West? PHD2 does not know either, so you just have to guess, and you have a 50-50 chance of getting it right. If you choose correctly, the new drift line will be flatter (less steep, closer to horizontal) If you choose incorrectly, the drift rate will increase (more steeply downward in the example above.). Click the Adjust button. PHD2 will stop guiding, and you can make your adjustment. You'll see something like this.

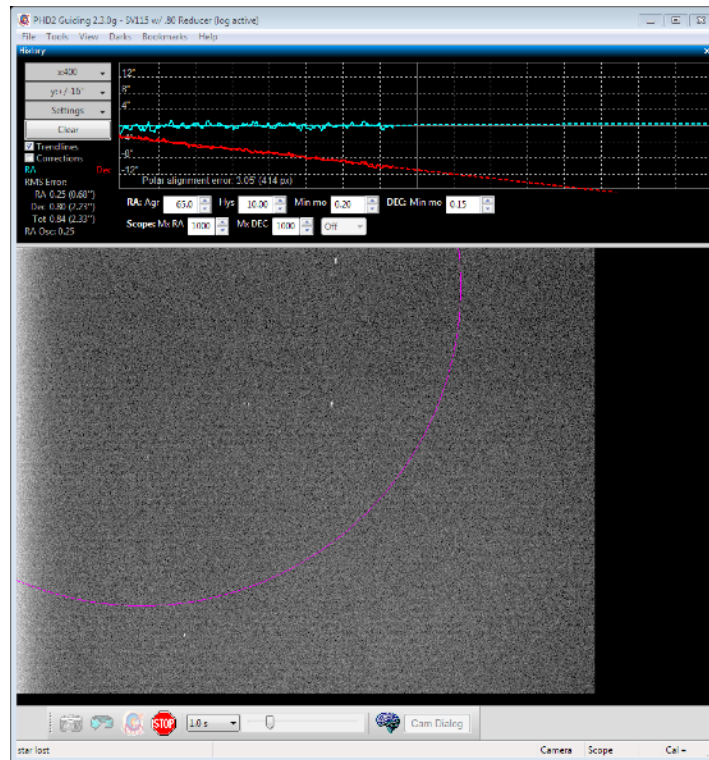

Slowly turn your mount's Azimuth adjustment, watching the screen and moving the guide star towards the magenta circle. The magenta circle shows how far the guide star needs to move. The magenta circle is larger when the Dec slope is steeper, and it may initially be so large that it is not visible on the screen. That's to be expected; if it is not visible, just move the guide star approximately the width of the screen. If you do see the magenta circle, you should move the guide star to the circle, like this:

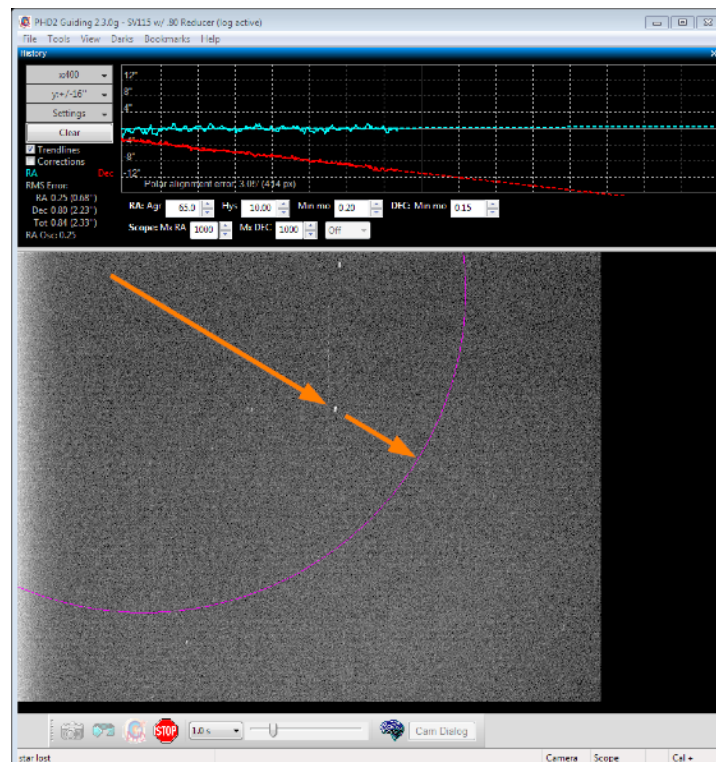

After moving the guide star, click Drift to take another measurement. Before you click Drift, it's OK to nudge the mount to re-center the star, or to find a different star, or to get back closer to the meridian. Also, you can choose your own guide star by clicking on it, or just let PHD2 choose. After a short time drifting, you will have another Dec trend line. Did it get better (closer to horizontal) or worse (away from horizontal)? Make a note to yourself in the "Azimuth adjustment notes" area of describing how you adjusted azimuth, and which direction the Dec slope moved. You can use this information next time you drift align so you do not have to guess which way to make the azimuth adjustment. For example, with my setup, turning the azimuth knob clockwise makes the slope go down. Having the note there reminds me that I need to turn the azimuth knob counter-clockwise to make the slope go up. Repeat the measurement and adjustment of the mount until you achieve a good flat horizontal dec trend line, like this:

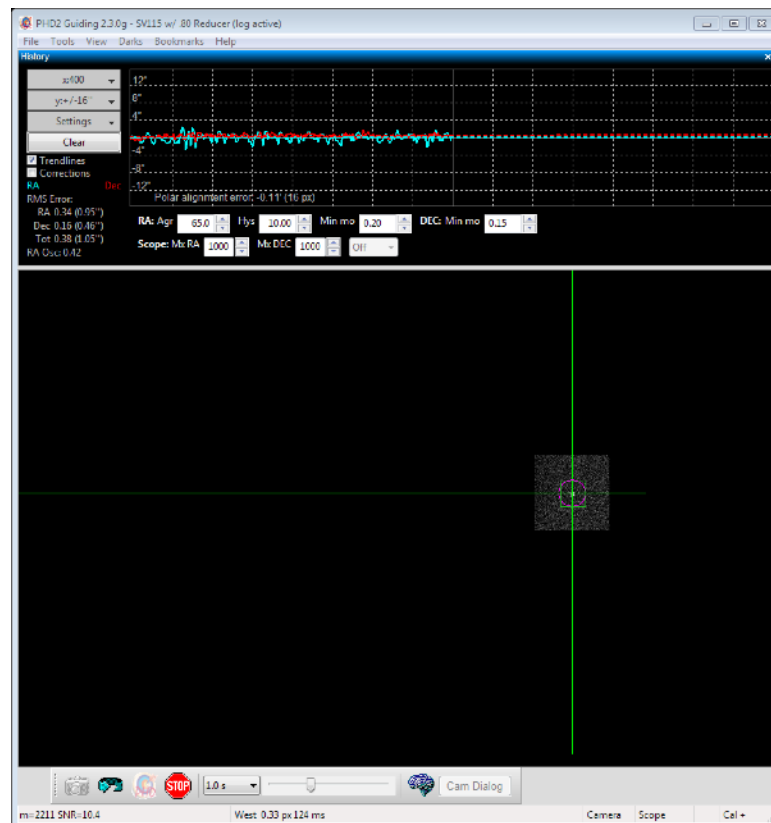



## Altitude Alignment

Now, you will need to repeat the process for the mount's Altitude adjustment. Click the Altitude button; the Drift tool will now look like this:

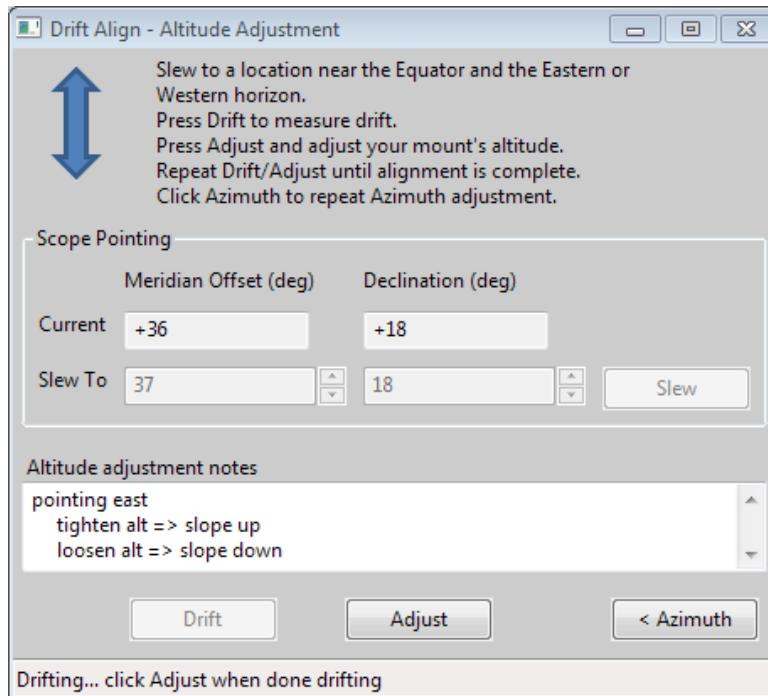

**Drift Align - Altitude Adjustment**

Slew to a location near the Equator and the Eastern or Western horizon.  
Press Drift to measure drift.  
Press Adjust and adjust your mount's altitude.  
Repeat Drift/Adjust until alignment is complete.  
Click Azimuth to repeat Azimuth adjustment.

Scope Pointing

	Meridian Offset (deg)	Declination (deg)	
Current	+36	+18	
Slew To	37	18	Slew

Altitude adjustment notes

pointing east  
tighten alt => slope up  
loosen alt => slope down

Drift      Adjust      < Azimuth

Drifting... click Adjust when done drifting

Click Slew or manually slew your mount towards the horizon (East or West):



The exact position is not important, but 25-35 degrees above the horizon works well. Click Drift to start drifting.

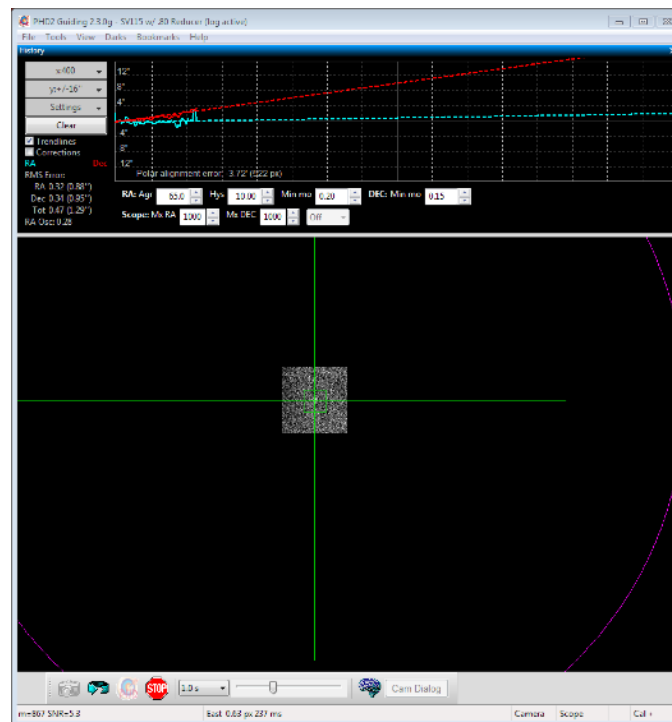

Drift until you have a stable Dec slope. Click Adjust, then turn the mount's Altitude adjustment knob. Use your notes recorded in the "Altitude adjustment notes" area from a previous session to determine which way to turn the knob to move the slope in the desired direction. For example, with my setup I turn the altitude knob clockwise to make the slope go "down". Just as with the Azimuth adjustment, repeat cycles of Drift and Adjust making the measurements and moving the guide star to the magenta circle. Again, the goal is to get the dec drift line to be horizontal.

### Note about ASCOM

The instructions and screenshots above correspond to what you see in PHD2 with an ASCOM connection to the mount. There are a couple differences if you do not have an ASCOM connection.

- The scope pointing information and the Slew button are disabled. You'll need to manually slew the mount to the required location.
- The solid magenta circle becomes a dashed-line magenta circle. The dashed magenta circle represents a limit to how far the guide star needs to move, not the exact distance. We only know that the star should not move past the circle. Rather than moving the star all the way to the circle, you may want to only move it half-way or so as an initial guess. You can use Bookmarks to keep track of where the guide star was in each Drift/Adjust iteration.

## Q & A

*Q: Where to save my pictures or videos?*

A: You can save captured images or videos directly on the hard disk of EAGLE. You can also connect a USB stick to one of the USB ports of the EAGLE, and then set the capture software you use to save images directly into the USB stick. This way, if you have an external computer that you use to process images for astrophotography, you can easily move your images.

*Q: Can I use EAGLE as a normal desktop computer?*

A: Sure. EAGLE has an HDMI monitor port to connect an external display. Then connect a USB mouse and a USB keyboard to 2 USB ports of the EAGLE. Connect the power supply (or battery) to the power port of the EAGLE and press the on/off button to make using the EAGLE as it was a normal desktop computer.

*Q: Can I change the operating system of EAGLE?*

A: The remote control settings of your EAGLE are implemented in the operating system. So if you format the EAGLE's SSD drive, you will lose the functions of the wireless remote control. Since the version of the operating system does not imply real changes in the functionality of the telescopes (that indeed depend on the astronomy software installed), we advise you not to make changes in the EAGLE pre-installed operating system.

*Q: What devices can I use to control EAGLE remotely?*

A: You can use any smartphone, tablet (running iOS or Android) or computer (with Windows or MacOS) installing the application "Microsoft Remote Desktop" or "Parallels RD client".. For ease of use we recommend devices with a screen size of at least 8 inches.

*Q: Can I command EAGLE from my Apple computer?*

A: Sure. Access to the OS X App Store and search for "Microsoft Remote Desktop" or "Parallels RD client" app. Install it and follow the instructions in this manual to set the remote control.

*Q: Can I control multiple devices simultaneously EAGLE?*

A: No, when you access to EAGLE with a new device, the connection to the previous devices is stopped and EAGLE will only appear in the new device.

*Q: During remote connection, power out and USB ports are no more active in the EAGLE Manager software, how can I fix this?*

A: Enter in ADVANCED SETTINGS and click on RECONNECT button, ports will be reactivated.

*Q: Sometimes I see a temporary connection drop and then it starts again, is this normal?*

A: Using the EAGLE, sometimes you can have a drop out and then connection is automatically resumed. This is caused by a temporary loss of connection by the Remote Desktop Client also if the WiFi connection is unstable. This is normal, the Client you use should automatically reconnect to the EAGLE.

*Q: Why does my SSD show up as smaller than advertised?*

A: Your drive shows up smaller than advertised because storage drive capacity is calculated and reported slightly differently than other capacities in computing. The drive capacity is reported on the assumption that 1GB is

1,000,000,000 bytes. A 480GB SSD is, in other words, actually 480,000,000,000 bytes. Windows OS uses binary bytes, so 1,024 bytes per Kilobyte, 1,024 KB per Megabyte, and so on. This means that when you have a 480,000,000,000 bytes storage drive into a Windows computer, that computer converts the number of bytes into gigabytes by dividing by 1024 all the way up through the scale, not by dividing by 1,000. So:

$480,000,000,000 \text{ Bytes} / 1,024 = 468,750,000 \text{ actual Kilobytes}$

$468,750,000 \text{ KB} / 1,024 = 457,764 \text{ actual Megabytes}$

$457,764 \text{ MB} / 1,024 = 447 \text{ actual Gigabytes}$

This is why a 480GB SSD will be correctly reported by a Windows computer as 447GB.

## Add EAGLE's ports control in external software

EAGLE Manager 4 has a web server that allows third party software, installed on the EAGLE, to take control of the EAGLE's ports. This paragraph describes the commands that allows you to control the EAGLE ports status independently from EAGLE Manager software. Web server replies to port 1380 and all replies are in json format. In order to correctly use this, please remember to update to the latest EAGLE Manager in your EAGLE. When the EAGLE's ports are controlled by third party softwares, the EAGLE Manager is always visible and the port status is always updated, also during capture.

### PLEASE NOTE

1) This paragraph describes commands needed to software programmers to develop third party softwares. If you don't know what these commands are and/or if you are not a software programmer, please don't use these commands. The use of these commands is by your own risk and PrimaLuceLab has no responsibility on any application of these commands and integration on third party softwares. If you have problems related to the use of the EAGLE with third party softwares, please refer to the third party software support.

2) **EAGLE4 webserver is different from previous EAGLE versions**

3) Commands shown here are related to EAGLE Manager 4.1

### REPLIES:

*http://localhost:1380/getsupply*

replies with the voltage of the EAGLE power supply. Example: {"result":"OK","supply":12.2}

*http://localhost:1380/getpwrou?idx=1*

replies with the voltage set in the 12V out ports (the ones to connect cameras, mounts, accessories, etc) with indexes from 1 to 4, their currents, voltages and "label" value. Example: {"result":"OK","voltage":12,"current":1.2,"power":12, "label":"camera"}

*http://localhost:1380/getpwrhub?idx=1*

replies with activation status of the USB 2.0 ports with indexes from 1 to 4 and "label" value. Example: {"result":"OK","status":1,"label":"mount"}

*http://localhost:1380/getregout?idx=5*

replies with the voltage set in the RCA ports (the ones for dew heaters) with indexes from 5 to 7, their currents, voltages and "label" value.

Example: {"result":"OK","voltage":8.4,"current":1.23,"power":10,"label":"dew heater"}

*http://localhost:1380/setpwrou?idx=1&state=1*

Turn on or off the 12V power out ports with indexes from 1 to 4. Reply: {"result":"OK"}

*http://localhost:1380/setpwrou?idx=2&label=Camera*

Set label of the power port 2 to "Camera". Reply: {"result":"OK"}

### PORT INDEXES

12V power out port number 1: 1  
 12V power out port number 2: 2  
 12V power out port number 3: 3  
 12V power out port number 4: 4  
 0-12V power out port number 5: 5  
 0-12V power out port number 6: 6  
 0-12V power out port number 7: 7  
 USB 2.0 A port: 1  
 USB 2.0 B port: 2  
 USB 2.0 C port: 3  
 USB 2.0 D port: 4

<http://localhost:1380/setregout?idx=5&volt=9.2>

Set the voltage in RCA ports voltage with indexes from 5 to 7. To turn off, set the voltage to 0. Reply: {"result":"OK"}

<http://localhost:1380/setregout?idx=5&label=Heater>

Set label of the power port 5 to "Heater". Reply: {"result":"OK"}

<http://localhost:1380/setpwrhub?idx=1&state=1>

Turn on or off USB 2.0 ports with indexes from 1 to 4. Reply: {"result":"OK"}

<http://localhost:1380/setpwrhub?idx=3&label=Mount>

Set label of USB 2.0 C port to "Mount". Reply: {"result":"OK"}

<http://localhost:1380/getecco>

Asks for actual state of the ECCO module.

Reply 1: {"result":"OK", "ecco":"Not connected"}

Reply 2: {"result":"OK", "ecco":"Connected", "temp":"25.1", "hum":"45", "dew":"26.2", "temp5":"25.3", "temp6":"25.4", "temp7":"25.5"}

<http://localhost:1380/setdarkmode?active=1>

Turn on DARK mode

<http://localhost:1380/setdarkmode?active=0>

Turn off DARK mode

<http://localhost:1380/getdarkmode>

Replies {"result":"OK","darkModeActive":0/1}

<http://localhost:1380/geteye?idx=0>

Front EYE sensor

<http://localhost:1380/geteye?idx=1>

Rear EYE sensor (the one close to 12V power ports)

replies {"result":"OK","value":123.456}

<http://localhost:1380/getgps>

Replies values (result,latitude,longitude,altitude,date,time,numsat)

<http://localhost:1380/connectecco>

Connect to ECCO

<http://localhost:1380/getall>

Replies with all the data coming from all the EAGLE's ports and sensors

**Note on EAGLE Manager integration:**

**The EAGLE Manager is not to be modified and it must be automatically started at Windows startup (as it is default in the EAGLE), also when the EAGLE's ports are controlled through third party software.** In order to do this, a proper command allows to lock the EAGLE Manager interface in the moment you connect the EAGLE to third party software. Command example:

```
/lockInterface?t=#####
```

the parameter *t=#####* (##### is a number) set the time in seconds to freeze the EAGLE Manager interface. For example:

- When a user start the control of the EAGLE ports from third party software, you have to send the command */lockInterface?t=36000* (to lock it for example for 10 hours)
- When the user disconnects the EAGLE control at the end of the capture (before disconnecting from third party software), you have to send the command */lockInterface?t=0*

This way, when the EAGLE's ports are controlled through third party software, the EAGLE Manager will always be updated and the EAGLE's port status can't be changed by clicking on the EAGLE Manager interface.

## Troubleshooting

### **Q: After I turn it on, I can't find the EAGLEXXXXXX WiFi network**

A: When the EAGLE is set in AP mode and you turn it on by pressing the ON button, after around 30 seconds (it depends on the EAGLE model you have) you should hear a beep sound which reports that the EAGLE's WiFi connection in AP mode is ready for connection. If you can't hear the beep sound, this may be related to:

- *EAGLE is set in HOST mode*: in this case the EAGLE is no more creating the AP WiFi connection but it's set to connect to a pre-existing network. If the EAGLE is set in HOST mode and you want to connect to the EAGLE in AP mode, press the RESET button on the left of the POWER button on the EAGLE case. This will reset WiFi network in AP mode. Then, in the device you use to control EAGLE from, you have to select the WiFi created by the EAGLE (EAGLEXXXXXX) and restart Remote Desktop software.

- *EAGLE is set in AP mode but I can't find any EAGLEXXXXXX WiFi network*: in this case first of all please try to select the EAGLE's WiFi network by using different devices. If you find it in all of them except one, this may be related to an incompatibility of that the devices WiFi card with the EAGLE's wifi network. If you can't find the EAGLE's WiFi network in any of your devices, with the EAGLE powered on, please connect it to an external monitor with an HDMI cable (it may be a computer or a TV screen) and check what you see in the screen:

- A) if you see Windows updating, please wait it to complete the update, after the update is completed you should see Windows booting and EAGLE Manager interface automatically starting, the EAGLE's WiFi should appear and you should be able to connect to it.
- B) if you see the password request (this may appear when you want to change the 4 digit password provided with the EAGLE), the EAGLE will create the WiFi network only after you will type the password. In order to fix this, please connect a USB mouse and keyboard to the EAGLE and click on Windows search field. Here type "netplwiz" then press ENTER in the keyboard. This will open a new window and you have to deselect the first option "Users must enter a name and password to use this computer.". Then press Apply and, if prompted, re-enter your password to confirm the changes. Then reboot and Windows should start without asking you the password. The EAGLE's WiFi should appear and you should be able to connect to it.
- C) If you see Windows with the EAGLE Manager set in AP mode, but you can't still find the EAGLE's WiFi network, please check that WiFi is ON. In order to do this, click on Windows START button (the icon to the bottom-left) and select the Settings icon. In the window that opens, please select "Network & Internet", then select WiFi and check that in the first option WiFi is ON. If it's off, please turn it on, then reboot your EAGLE and check if now you are able to find the EAGLE's WiFi network.
- D) If you see Windows with the EAGLE Manager set in AP mode and with the EAGLE WiFi is ON, please update WiFi card driver. In Windows, please select START button, select Control Panel and then Device Manager. Here you will find the list of devices connected to the EAGLE. Select "Network adapters", select the WiFi card (for example Intel Dual Band Wireless-AC 7265), make a right mouse click and select "Update software driver". EAGLE has to be connected to the Internet, for example with an ethernet cable to your router. In the window that opens, click on "Search automatically for updated software driver". Now restart Windows and check if WiFi works.
- E) If you checked all the previous points and you still can't find the WiFi network, please check for the WiFi antennas of the EAGLE. If there is an hardware issue related to the antennas, you can change the antennas and with another model and test. EAGLE uses standard WiFi antennas with *sma* connector and male central pin.
- F) If you checked all the points A, B, C, D, E and you still can't find the WiFi network, you may have an hardware issue, please write us to [support@primaluce.com](mailto:support@primaluce.com).





**Q: I'm able to find and connect to EAGLEXXXXXX WiFi network, but WiFi disconnects**

A: WiFi connection stability depends on many factors, one of them is the quality of the antenna built in the device you use to remotely control the EAGLE. Another factor is radio frequency interference that you may have especially in an indoor situation (typically when you install all your software and drivers in your EAGLE for the first time). Generally speaking, sometimes Remote Desktop connection to the EAGLE may drop out and then connection automatically restarts, this is normal and may be related to small levels of radio interferences. But this is related only to the Remote Desktop client and the WiFi connection to the EAGLE has to be constant. Instead, if you experience disconnections to the EAGLEXXXXXX network (and not related to the Remote Desktop client) this may be related to different factors, we analyze here:

- A) Limited WiFi range: the EAGLE's WiFi connection has been designed to allow you to connect to the EAGLE also from many meters of distance but the maximum range depends on many factors like the presence of walls (different materials) or windows, the quality of the antenna in the device you use to remotely control the EAGLE and radio interference. If you experience WiFi disconnections, please move closer to the EAGLE and test again. If WiFi connection becomes stable, you can install a WiFi extender in between the position of your EAGLE powered telescope and the device you use to control it. If you still experience WiFi disconnections when you're close to the EAGLE, please move to point B.
- B) Reduce radio interferences: radio interferences may be caused by other electrical devices you may have close to your EAGLE (for example WiFi routers), please move the EAGLE to a place away from possible interferences (for example, in the backyard where you use your telescope) and check if WiFi connection becomes stable. If you still experience WiFi disconnections, please move to point C.
- C) Update WiFi card driver: in Windows, please select START button, select Control Panel and then Device Manager. Here you will find the list of devices connected to the EAGLE. Select "Network adapters", select the WiFi card (for example Intel Dual Band Wireless-AC 7265), make a right mouse click and select "Update software driver". EAGLE has to be connected to the Internet, for example with an ethernet cable to your router. In the window that opens, click on "Search automatically for updated software driver". Now restart Windows and check if WiFi connection is now stable. If you still experience WiFi disconnections, please move to point D.
- D) Change WiFi settings in order to reduce radio interferences and improve compatibility with the device you use to control the EAGLE: in your EAGLE, please go to Control Panel -> System -> Device manager and select the WiFi card, you can do right mouse-click and select Properties. Here you will find some WiFi settings you can modify: for example you can choose if you want to operate 2.4 GHz, 5 Ghz or Dual Channel. You can choose the preferred bandwidth, and you can also modify the Wireless mode, based on the WiFi standards that are supported from the device you use to control the EAGLE. You can modify settings and find the ones that allows you to have a more stable WiFi connection. There is no a particular rule here because every setup is different since it may be impacted by different types of radio interferences. If you still experience WiFi disconnections, please move to point E.
- E) If you checked all the points A, B, C, D, and you still have WiFi disconnections (not related to Remote Desktop client disconnections), you may have an hardware issue. In this case please write us to [support@primaluce-lab.com](mailto:support@primaluce-lab.com) and we'll support you to fix the problem.

**Q: I connected a USB device to one of the USB ports of the EAGLE and it doesn't work**

A: Since the EAGLE includes also a Windows 10 64bit computer, it can control USB devices by properly installing the correct Windows 10 64bit drivers and softwares. Every USB devices has a different installation procedure, based on the manufacturer requirements so we suggest you to follow the user manual of the device you want to install in the EAGLE. But, for your advantage, you can quickly make this checks:

- 1) After you connect the device to one of the USB ports of the EAGLE (if you connect to one of the USB 2.0 ports, please verify that the status of the port is ON in the Eagle Manager), go to Windows Device Manager. Here you will see the list of the hardware devices of the EAGLE and connected to it.
- 2) If you still have to install the device driver in the EAGLE, you device won't be automatically recognized and it will be marked with a yellow sign (this means that the device can't be used until the driver is properly loaded).
- 3) Install in the EAGLE the device driver by following the manufacturer instructions.
- 4) Now you can click on the name of the unrecognized device with the right mouse button and select "Update Driver Software".

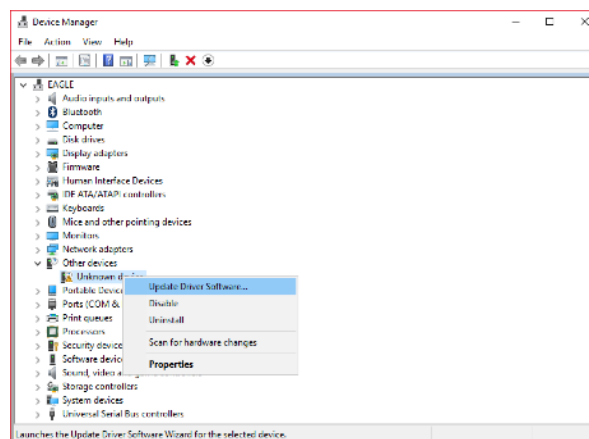
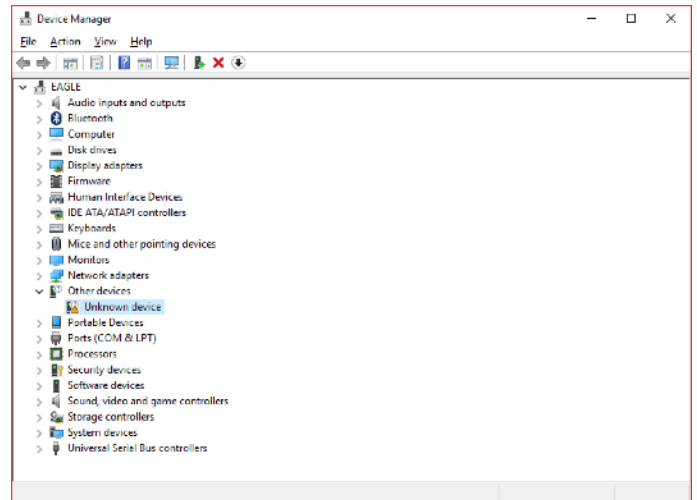

- 5) This will open a new window, please select "Browse my computer for driver software". In the window that opens select the folder where you previously installed the device driver, then click Next button.

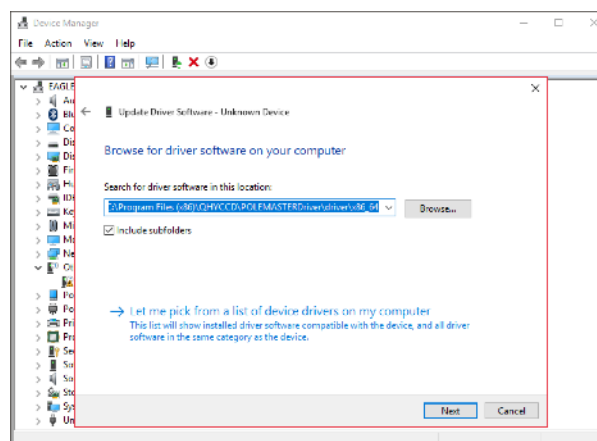

- 6) When the installation is complete, device will appear in the Device Manager list . You will be able to install its software for Windows 10 64 bits and use it.

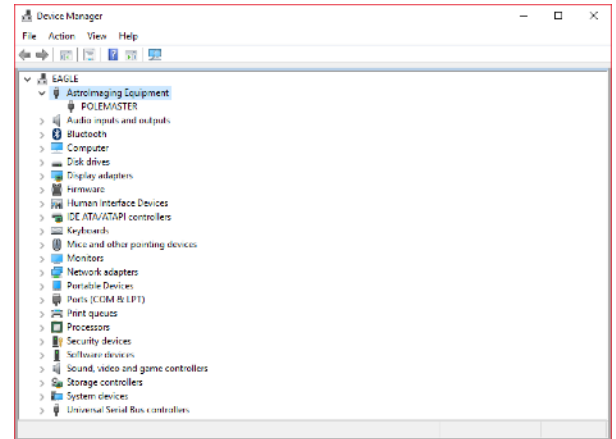

**Q: What have I to do if the EAGLE suddenly shuts down during use**

A: A sudden shut down of the EAGLE (with or without the power off of the other devices powered through the EAGLE) may be related to the power unit you use to power the EAGLE (and all the other devices powered through it), power cables or software settings. In order to fix this problem, please proceed this way:

- A) Change the power unit: please change the power unit or the battery you use to power the EAGLE with a new unit. For example, you can try to change the AC adapter with a battery with enough capacity and connect to it by using the 12V cigarette cable supplied within the EAGLE's box. If this fix the problem, you may have an hardware issue on the power unit you're using or you may have a field battery with not enough capacity. In this case, please change your power unit or battery. If you still have sudden shutdowns, please move to point B.
- B) Disconnect all the power out cables and test: a sudden power shutdown may be related to a short-circuit of a power out cable (from the EAGLE to an external device powered through the EAGLE) if the power consumption is high. Please disconnect all the power out cables and keep connected only the power cables that connects your power unit or battery to the EAGLE. If this fix the problem, you have a problem on one of the power-out cables, so test all of them with a multimeter tester and, when you find the not working cable, change or fix it (if you want to fix it and you have no experience on electrical parts, you may need the help of an expert). If you still have sudden shutdowns, please move to point C.
- C) Check for software settings: inside Windows operating system there are settings related to power management. Please click on the START button, then select Control Panel and then Power Options. Here please check that the "High performance" option is selected, then press "Change plan settings" to the right of the "High performance" option. In the new window that opens, please check that the "Turn off display" and "Put the computer to sleep" are both set to "Never". Then click on "Change advanced power settings". In the new window that opens, please check that these settings are set this way:
- Turn off hard disk after: 0 (zero - this means Never)
  - Wireless Adapter Settings - Power Saving Mode - Settings: Maximum Performance
  - Sleep after: 0 (zero - this means Never)
  - USB settings - USB selective suspend settings: Disabled
- D) A Windows Update not installing correctly may suddenly force a OS reboot: Microsoft developed a troubleshooter program specifically to fix problems related to Windows Update process. Please select START button, then select Control Panel and click on Troubleshooting. Here click on 'Fix problems with Windows Update' and follow the on screen instruction to proceed.
- E) If you checked all the points A, B, C, and you still have power problems, you may have an hardware issue. In this case please write us to [support@primalucelab.com](mailto:support@primalucelab.com) and we'll support you to fix the problem.

**Q: When I connect to power, the EAGLE beeps and the "act" LED is on, but I have no activity on the PW or SSD LEDs**

A: if you can hear the “beep” sound when you connect power to the EAGLE and the “act” LED is on, it means that EAGLE’s internal power board receives power from your power unit. But if you press the power ON button and the EAGLE doesn’t boot, before proceed, please connect the EAGLE to an HDMI monitor and check if you see any signal. If there is no activity on the monitor, please check the PW LED status:

### CAUTION

All these steps require knowledge on computers and may require to change internal components, so if you can’t do this or feel uncomfortable, please contact us writing an email to [support@primaluce.com](mailto:support@primaluce.com)

- 1) If the PW LED is off, you may have a problem related to the power ON button or a related to the motherboard power management. Please open the EAGLE case (there are 6 screws to remove on top of the EAGLE) and you will find, close to one of the corners, the internal power on button. By using a screw driver (or another tool) please press the internal power on button (the white button in the picture - **caution: do not touch other internal parts!**).

*If the EAGLE now starts*, you have an issue on the Power ON button, please write us to [support@primaluce.com](mailto:support@primaluce.com) and we’ll support you to fix the problem.

*If the EAGLE doesn’t start*, you may have a bad power source, try connecting the EAGLE to a different power unit. If with a different power unit the EAGLE starts, you have an issue on the previous power unit. If it still doesn’t start, unplug your EAGLE from the power unit and wait for more than 10 seconds. Then press the power button of your EAGLE a couple of times. Do this with no power source connected, then connect your EAGLE to the power unit again and try to turn it on. If it still doesn’t start, please disconnect the EAGLE power unit and open the EAGLE’s chassis. Here please check that the SSD drive is seated securely to the motherboard header. If it’s correctly connected, you may have a defective SSD drive: in this case you can try to install a new SSD drive (note: in this case you would also have to install on the new drive the backup copy of the EAGLE’s original SSD drive), connect EAGLE’s power unit and check if it boots. If the EAGLE still doesn’t boot, you may have a hardware issue on the EAGLE’s motherboard, so please please write us to [support@primaluce.com](mailto:support@primaluce.com) and we’ll support you to fix the problem.

- 2) If the PWR LED is blinking in a pattern of three, it means that the motherboard is not able to detect the memory module, or that the memory module is defective or that the memory module is the wrong voltage and/or incompatible. In this case remove disconnect the power unit from the EAGLE, then remove and reinstall the memory modules to make sure they are fully seated in the sockets. Connect the power unit again and check for the PWR

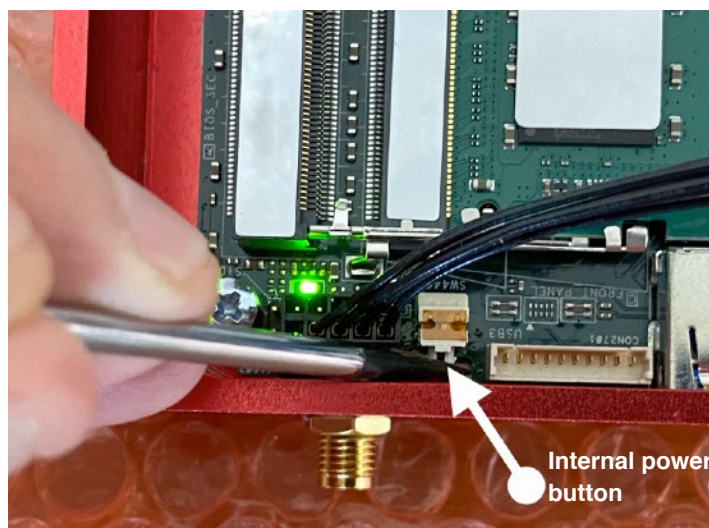

LED. If it's still blinking in a pattern of three, please check that the RAM modules have the correct voltage (in case you previously changed the ones installed as standard in the EAGLE): SODIMM DDR4 1,2V. If PWR LED is still blinking in a pattern of three, this may indicate defective memory. To isolate a specific module as defective, boot the system with just one installed at a time. You can also try testing suspected defective memory in a different computer. Then change the defective RAM module with another one with compatible specifications.

- 3) If the PWR LED is blinking in a different pattern, 2 red blinks indicated that the computer is in sleep mode (in this case this LED behaviour is normal for sleep mode, please press the power button to wake your EAGLE) while 16 on/off blinks indicates that the computer is overheating (in this case please check that chassis ventilation holes aren't blocked and unit has sufficient airflow).

***Q: I have a problem with Windows operating system, can I restore the factory settings?***

A: Before shipment, we record a "Windows recovery point" in the EAGLE units so you can immediately return back to the factory settings in a very easy way. Restoring won't affect your personal files but most likely will automatically solve your problem with Windows. In order to make a system restore please:

- 1) go to "Control panel"
- 2) select "Recovery"
- 3) select "Open System Restore" then press Next
- 4) choose the restore point (you will find the "EAGLE new" restore point")
- 5) press "Next" and then "Finish"

NOTE: if you perform a Windows Update, Windows will automatically delete this Recovery Point because it won't be compatible anymore with the previous Windows version. If you apply a Windows Update and the "EAGLE new" recovery point is deleted, we suggest you to make a new Recovery Point and always have one available. Please proceed this way:

- 1) go to "Control panel"
- 2) click on "System"
- 3) select the tab "System protection" then press the button "Create"
- 4) in the window that opens, please type the name of the restore point you want to create
- 5) press "Create" to create the restore point

If you haven't a Restore Point always available and if you don't create a SSD backup (by following the guide in one of the previous paragraphs in this user manual) , if you will have a problem with the Windows operating system you will have to ship the EAGLE to our laboratory in order to reset the EAGLE to factory conditions (in this case all the files, softwares and documents included in your EAGLE's SSD drive will be deleted).

***Q: After connecting power and pressing the ON button, STS LED doesn't turn green***

A: STS LED light states Windows status after Windows boot. If after pressing the ON button of EAGLE and waiting about 1 minute, the STS LED light does not turn green, it means that EAGLE failed to start Windows. Please connect the EAGLE to an external HDMI monitor and press the ON button, the look at what you can see on the monitor.

## INFORMATION TO USERS



According to art. 26 of Decreto Legislativo 14 marzo 2014, n. 49 "Attuazione della Direttiva 2012/19/UE sui rifiuti di apparecchiature elettriche ed elettroniche", the symbol of the barrel placed on the equipment or its packaging indicates that the product at the end of its useful life must be collected separately from other waste.

The user will therefore have to give the end-of-life equipment to the appropriate separate collection centers for electronic and electrotechnical waste or to return it to the reseller upon the purchase of a new type of equivalent equipment, one by one.

Properly differentiated collection for the subsequent start of dismantled equipment for recycling, treatment and environmentally compatible disposal helps to avoid possible adverse effects on the environment and health and favors the reuse and / or recycling of the materials contained in the equipment.

The abusive disposal of the product by the user implies the application of the administrative sanctions as per D.Lgs. 152/2006.

*Compliance with the RAEE legislation (D.Lgs. 49/2014)*

*PrimaLuceLab is registered to AEE Register with number IT17030000009790*

*PrimaLuceLab adheres to Sistema Collettivo ERP Italia for the compliance to RAEE legislation.*



---

## WARRANTY

---

- 1) The PrimaLuceLab product warranty is effective from the date of purchase and is valid only if it is with the invoice (or receipt) of purchase.
- 2) The warranty covers the product against defects in workmanship and includes the cost of the replaced material and labor.
- 3) The warranty does not cover any damage caused to the product or defects or failures that occur due to improper installation , improper use and/or deterioration due to normal wear.
- 4) THE GUARANTEE DOES NOT APPLY IN THE FOLLOWING CASES:
  - Repair by anyone not authorised by PrimaLuceLab .
  - Invasive interventions or tampering with internal and/or external parts.
  - Missing of the invoice (or receipt) of purchase.

### TERMS OF SERVICE

Technical assistance is performed exclusively by PrimaLuceLab or its authorised resellers. All returns must be received with our permission (to be asked writing an email to [support@primalucelab.com](mailto:support@primalucelab.com)) . YOU HAVE TO add to the shipping the invoice (or receipt) of purchase and the detailed description of the defect. For products without the invoice (or receipt) of purchase, repair and shipping costs are always paid by the customer.